

VCM-810

8" TFT-LCD SCREEN WITH DVD PLAYER

OVERHEAD COMBO

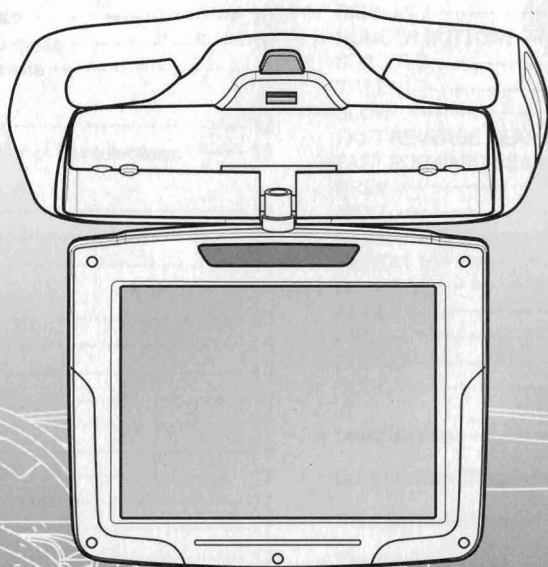

CAUTION

Changes or modifications not expressly approved by the party responsible for compliance could void the user's authority to operate the equipment.



Contents

■ Caution	4	■ DVD Functions	24
■ Name and function of each parts	6	EJECT	24
– UNIT	6	VOL+ / VOL-	24
– Remote Controller	8	MUTE	24
■ How to operate the monitor	9	PLAY OR PAUSE	24
– Releasing the monitor	9	AUDIO	24
– POWER On/Off	9	STOP	25
■ Selecting the mode	10	ARROWS	25
– How to select DVD mode	10	SETUP	25
– How to select AV mode	11	MENU	25
■ Picture Control	12	DISPLAY	26
– Contrast, Bright, Color or Tint selections:	12	NUMBER BUTTONS	26
■ Extra Functions	13	SUBTITLE	27
– REVOLVE	13	TITLE	27
– RESET	14	SLOW	27
■ DVD Setup	15	FAST REVERSE SEARCHING	28
– SETUP MENU	15	FAST FORWARD SEARCHING	28
– GENERAL SETUP	16	PREV	29
TV DISPLAY	16	NEXT	29
ANGLE MARK	16	REPEAT A-B	29
OSD LANG	16	REPEAT	30
CAPTIONS	17	NTSC/PAL	30
SCREEN SAVER	17	ANGLE	30
LAST MEMORY	17	PBC	31
– AUDIO SETUP	17	ZOOM	31
DOLBY DIGITAL SETUP	17	GOTO	31
EQUALIZER	18	■ Installation	32
– VIDEO SETUP	19	■ Connection Diagram	33
QUALITY	19	■ Disc Information	34
– PREFERENCE	21	■ Troubleshooting	35
TV Type	21	■ Specifications	36
PBC (Play Back Control)	21		
AUDIO	21		
SUBTITLE	21		
DISC MENU	22		
PARENTAL	22		
COUNTRY REGION	22		
DEFAULT	22		
– PASSWORD SETUP	23		
PASSWORD MODE	23		
PASSWORD CHANGE	23		

A grade screens constitute no more than 3 missing pixels.

Caution

Please read and observe all warnings and instructions in this owner's manual and those marked on the unit. Retain this booklet for future reference.

There are two kinds of alarm symbols as follows:



WARNING

The lightening flash with arrowhead symbol within an equilateral triangle is intended to alert the user to the presence of "dangerous voltage" within the product's enclosure that may be of sufficient magnitude to constitute a risk of electric shock to people.



CAUTION

The exclamation point within an equilateral triangle is intended to alert the user to the presence of important operating and maintenance (servicing) instructions in the literature accompanying the product.

WARNING



Installation of all TV monitors must be out of the driver's field of sight.



Do not mount the product where it will obstruct the deployment of the airbag or in an area where it would affect the vehicular control. Also be careful to avoid mounting the product where it can become hazardous during sudden stops or in the event of an accident.



Do not try and service these products yourself, seek only a qualified service center or factory service center.



Be careful not to drop or apply under pressure to the front panel of your video monitor. If the screen cracks due to misuse, your warranty will be void!



Be careful not to overload your cigarette lighter plug by adding more than one device at a time.



Use only a damp cloth to clean the screen and use only purified water on the cloth, wring out all excess water prior to wiping the screen. Do not use any cleaners or chemicals to clean the screen. In most cases a dry cloth will do!

Caution

CAUTION



Quality installations are best performed by qualified and certified installers.



Watching the monitor for an extended period of time without the engine running may deplete the vehicle's battery charge.



Don't touch the unit there is a flash of lightening. It may receive an electric shock.



This product is designed for operation with a 12 Volt DC, negative ground vehicle. It is not suitable for operation under other conditions or voltages.



Do not cover or stop up heater ducts or vents. It may be the origin of a fire or receives an electric shock.

Check Point

1. The operating temperature of this product is limited to $-4^{\circ}\text{F} \sim +176^{\circ}\text{F}$. Your vehicle can reach temperatures up to 212°F in the summertime.
2. From time to time when your vehicle is extremely hot or cold you must allow time for your air conditioner or heater to cool or heat the vehicle and for operating temperatures to return to normal operating ranges. Your monitor will return to its normal functions when these operating ranges are achieved.
3. Your optimum picture quality is achieved when you are directly in front of the monitor (+/-30 degrees).
4. Do not open covers and repair yourself. Refer servicing to qualified personnel.
5. DVD Players use an invisible laser beam which can cause hazardous radiation exposure. Be sure to operate the unit correctly as instructed.
6. Do not cut the car power supply off while a disc is playing. It can cause damage to the DVD Player.

6 Name and function of each parts

UNIT

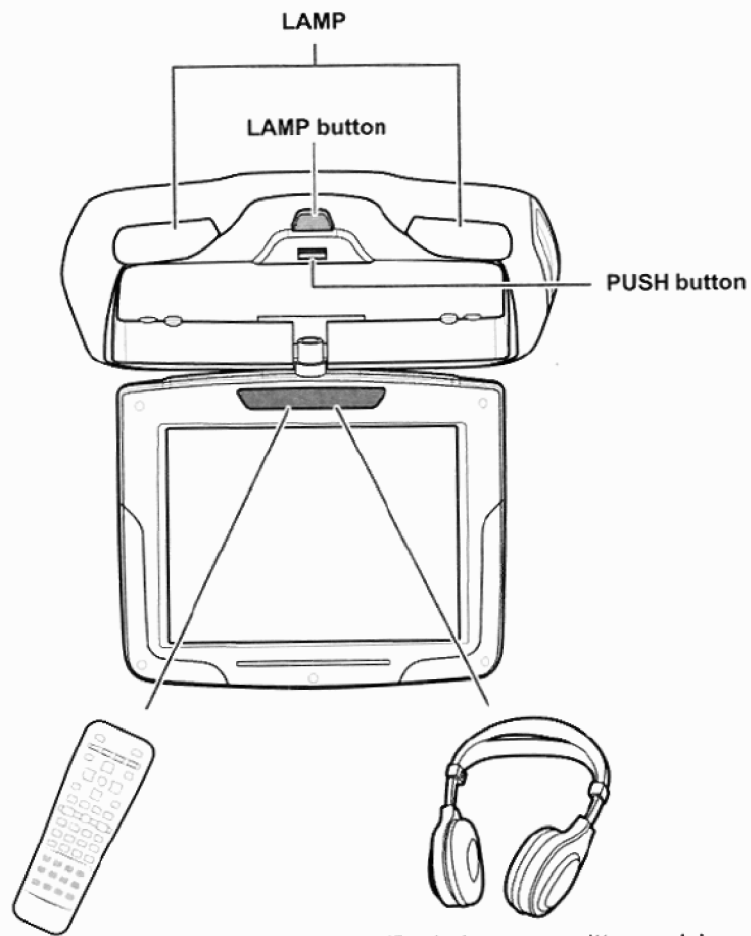

Remote control eye.
 This allows transmitting of the remote control's IR signals for controlling all functions of your monitor.

IR wireless transmitter module
 This module sends the audio signal to aftermarket wireless IR headphones. The audio signal is converted to an infrared light transmitted to your headphones by line of sight. You only have to be in view of the IR transmitter.

7 Name and function of each parts

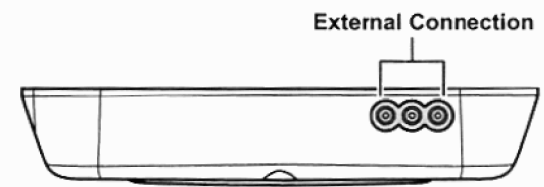
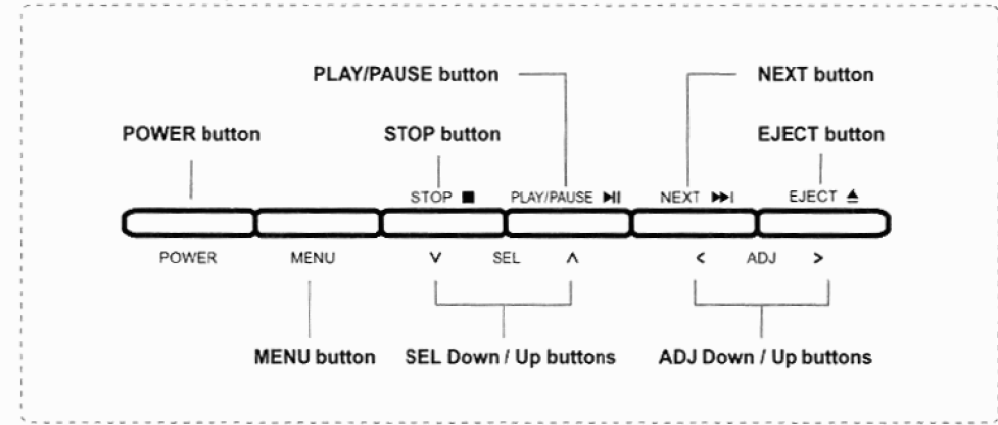
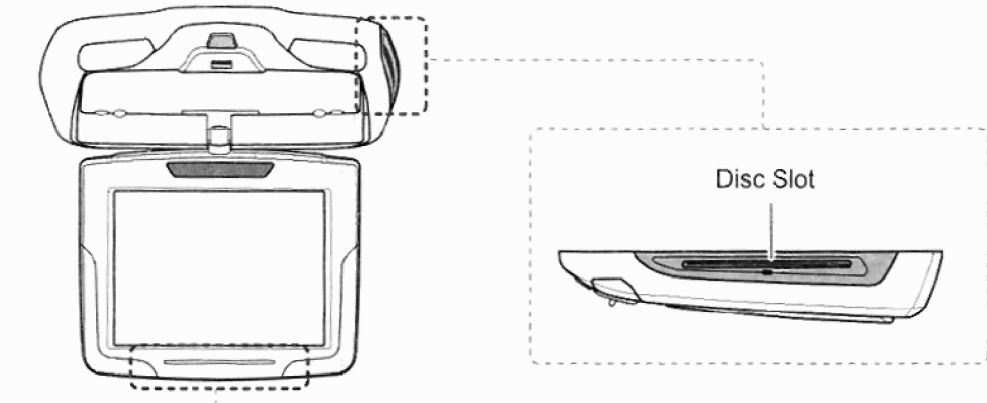

Name and function of each parts

Remote Controller

EJECT button
OPEN/CLOSE the disc tray.

TITLE button
Use to display the title menu of the loaded DVD disc.

ARROW button
Use to move to the desired menu.

ENTER button
Use to select the menu item.

DISPLAY button
Shows information of elapsed or remaining time of a chapter or a title.

FR button
Use to play reverse silently.

STOP button
Stops disc play.

SLOW button
Use to play slow silently.

FF button
Use to play forward silently.

PREVIOUS button
Use to move to the previous chapter of track.

PLAY/PAUSE button
Begins/pauses disc play.

NEXT button
Use to move to the next Chapter or track.

MONITOR CONTROL

POWER button
Turns on the Monitor.

PICTURE button
Use to adjust the picture settings.

ADJ button
Adjustment in each mode.

(These functions are valid for only some products.)

POWER button
Turns the DVD Player & Unit on or off.

MODE button
Changes each Play mode.

SETUP button
Use to set various functions according to your individual preference. (Auto Memory : Not use)

MENU button
Shows the menus. (ADD/DEL : Not use)

MUTE button
Use to cut the sound on or off.

ZOOM button
Zoom in on picture.

AUDIO button
selects the setting of the desired audio output.

GOTO button
Use to search a title or a chapter of your DVD disc.

NUMERIC button
Use when making a selection on the menu screen.

SUB-T button
Changes the subtitle language to another (available) language.

NTSC/PAL button
Select the NTSC/PAL in condition of DVD mode.

PBC (Play Back Control) button
When you play a VCD 2.0 disc the root menu screen will be displayed on the monitor.

REPEAT button
Repeats part or all of a chapter, title or track, or an entire disc.

A-B button
Repeat the selected segment. (Audio or Video)

ANGLE button
This button can control the preset camera angle.

VOL UP button
Increases the volume.

VOL DOWN button
Decreases the volume.

How to operate the monitor

Releasing the monitor

Push the open button (located on the front of your screen) and lower the monitor to the desired level. You can also adjust the swivel angle.

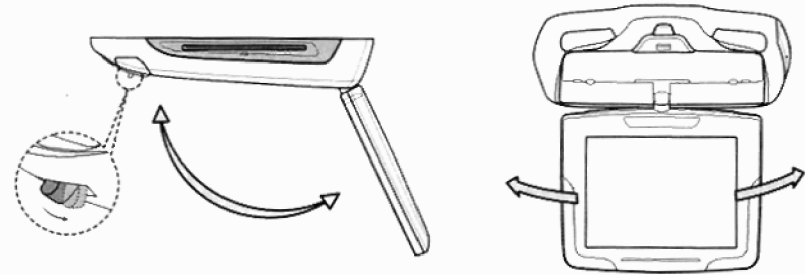

POWER On/Off

1. Press the **POWER** button on either the remote control or the unit once to turn the power on. Press the same **POWER** button to turn the power off.

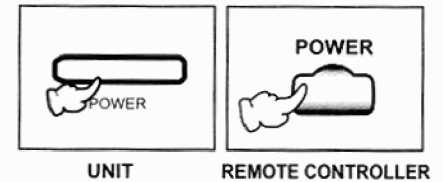

Selecting the mode

Press the **MODE** button on the remote control to achieve the desired mode.

How to select DVD mode

1. Bring up the on-screen picture control menu by pressing the **PICTURE** button on the remote control or the **MENU** button on the unit.

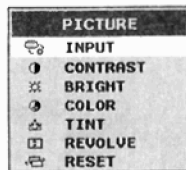

2. Select the **INPUT** menu by pressing the **PICTURE** button on the remote control or the **MENU** or **SELV/Λ** buttons on the unit to move the cyan-colored cursor window up or down. Highlight the **INPUT** menu.

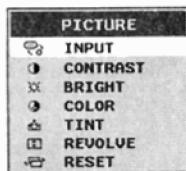

3. Adjust the current settings with the **ADJ - / +** buttons on the remote control or the **ADJ < / >** buttons on the unit to achieve the desired **DVD** mode.

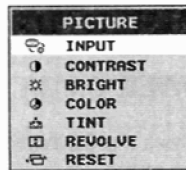

4. Load a disc in the disc loading slot with the label side up.

Insert a disc in the disc loading slot and it will be played automatically.



Selecting the mode

How to select AV mode (External Connection)

1. Connect all devices as shown in the diagram. Shut off all power prior to connection.

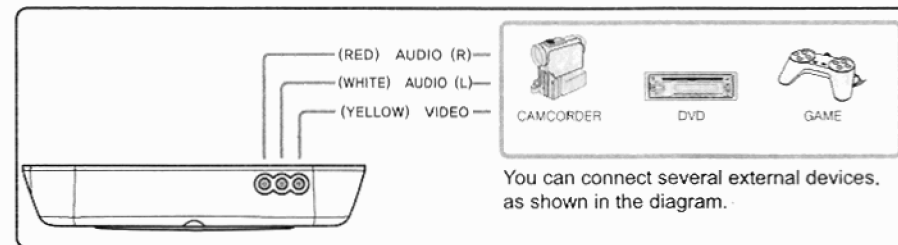

2. Turn on the power to the **UNIT** and other devices.

3. Bring up the on-screen picture control menu by pressing the **PICTURE** button on the remote control or the **MENU** button on the unit.

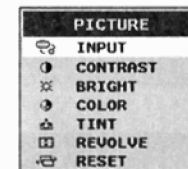

4. Select the **INPUT** menu by pressing the **PICTURE** button on the remote control or the **MENU** or **SELV/Λ** buttons on the unit to move the cyan-colored cursor window up or down. Highlight the **INPUT** menu.

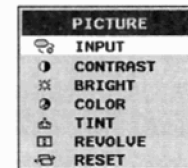

5. Adjust the current settings with the **ADJ - / +** buttons on the remote control or the **ADJ < / >** buttons on the unit to achieve the desired **AV** mode.

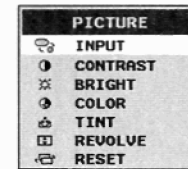

6. Play an external device.



Picture Control

● Contrast, Bright, Color or Tint selections:

Use to achieve the desired settings.

1. Bring up the on-screen picture control menu by pressing the **PICTURE** button on the remote control or the **MENU** button on the unit.

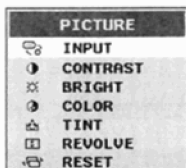

2. Select the desired menu by pressing the **PICTURE** button on the remote control or the **MENU** or **SEL V/Λ** buttons on the unit to move the cyan-colored cursor window up or down. Highlight the desired function to change Contrast, Bright, Color, Tint etc.

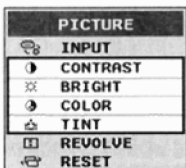

3. Adjust the picture conditions with the **ADJ - / +** buttons on the remote control or the **ADJ < / >** buttons on the unit to achieve the desired settings.

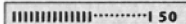
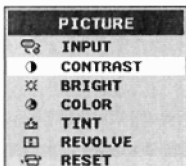

Extra Functions

● REVOLVE (Vertical Revolve Function)

Watching the 180° revolved picture as you want.

1. Bring up the on-screen picture control menu by pressing the **PICTURE** button on the remote control or the **MENU** button on the unit.

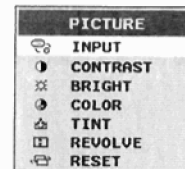

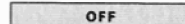
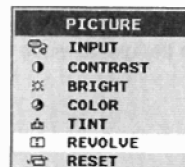

2. Select the **REVOLVE** menu by pressing the **PICTURE** button on the remote control or the **MENU** or **SEL V/Λ** buttons on the unit to move the cyan-colored cursor window up or down. Highlight the **REVOLVE** menu.

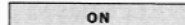
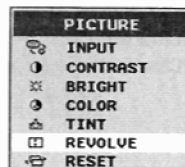

3. Adjust the picture conditions with the **ADJ - / +** buttons on the remote control or the **ADJ < / >** buttons on the unit.



Setting	OFF	ON
Picture Conditions	 Cat	Cat 



Extra Functions

● RESET Function

This Function will reset the same as factory setting conditions.

1. Bring up the on-screen picture control menu by pressing the **PICTURE** button on the remote control or the **MENU** button on the unit.

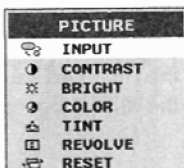

2. Select the **RESET** menu by pressing the **PICTURE** button on the remote control or the **MENU** or **SEL V/Λ** buttons on the unit to move the cyan-colored cursor window up or down.

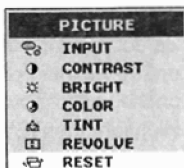

3. Reset the all functions with the **ADJ - / +** buttons on the remote control or the **ADJ < / >** buttons on the unit.

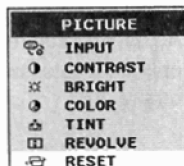

DVD Setup

■ SETUP MENU-MAIN PAGE

- ⊘ An invalid button press.

When this symbol appears, it indicates that an invalid button has been pressed. There are some differences between real functions and functions in manual.

You can easily modify setup information on the setup menu.

When the **SETUP(A.MEMO)** button is pressed, the monitor screen shows the setup menu as shown below. Select a menu category to modify according to individual preference.

1. Press the **STOP** button, if the disc plays.
2. To bring up the **SETUP** menu, press the **SETUP(A.MEMO)** button.

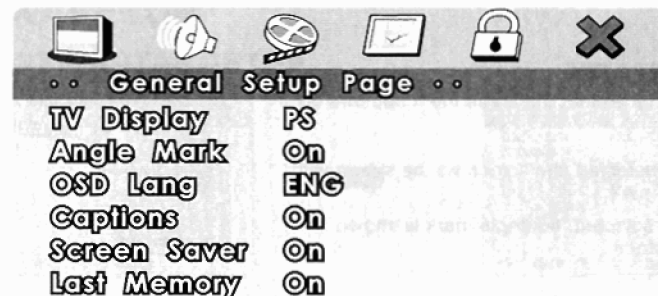

Go To General Setup Page

3. Use the button to find desired items.
4. To turn off the **SETUP** menu, press the **SETUP(A.MEMO)** button again.

GENERAL SETUP

1. TV DISPLAY

You can select a TV screen aspect ratio according to your TV. If the TV on which the movie is played "WIDE type", choose "WIDE". If it is of "4:3" type, choose NORMAL/PS(Pan & Scan) or NORMAL/LB(Letter BOX).



NORMAL / PS 4:3 PAN & SCAN

Choose this setting if you want the movie to fill the entire screen. (This might mean that the left and right edges won't be seen)



NORMAL / LB 4:3 LETTER BOX

Choose this setting if you want to see movies in their original aspect ratio. (The movie might appear with black bars at the top and bottom of the screen.)



WIDE 16:9 WIDE SCREEN

Choose this setting if your DVD Player is connected to a widescreen TV. (This option is available only if the disc has a 16:9 display aspect ratio.)

Caution

This option is available only when the disc has the function.

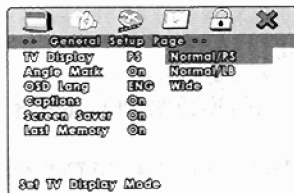

2. ANGLE MARK

You can set up so that the angle mark appears on scenes.

On : When selected, the screen will be shown with angle mark.

Off : When selected, no angle mark is shown on the screen.

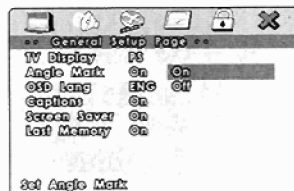

3. OSD LANG

Use this option to set the OSD language. When selected, change to set the on-screen display language.



4. CAPTIONS

Adjust caption selection.

On : Choose this setting to display captions.

Off : Choose this setting to close captions.

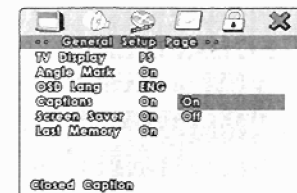

5. SCREEN SAVER

The screen saver is useful to prevent your display from becoming damaged. The screen saver picture appears when you leave the DVD player in stop mode for about two minutes.

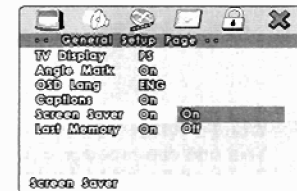

6. LAST MEMORY

Adjust last memory selection. when start your car or turn on/ off the DVD player, search the latest played scene. When eject and close the disc, this function is not working.

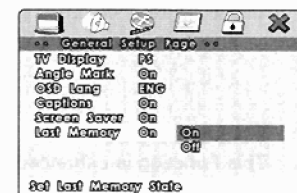

AUDIO SETUP

1. DOLBY DIGITAL SETUP

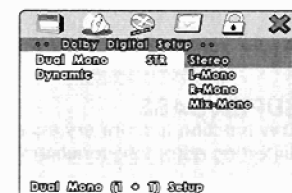
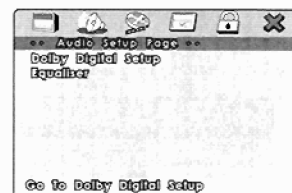

DUAL MONO

Use this function to set the input audio signal to fit into the speaker.



DYNAMIC

Use this function to change the setting from the factory. - Preset Off position.



2. EQUALIZER

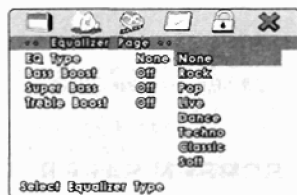
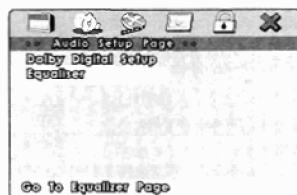

EQ TYPE

This unit can produce a 3D surround effect, using 3D Surround Sound technology. Choose the desired preset equalizer mode. (None, Rock, Pop, Live, Dance, Techno, Classic, Soft)

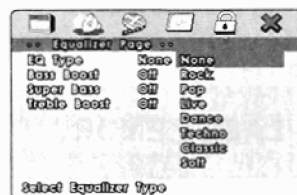

BASS BOOST

This Function is enhanced at low levels without distorting other frequencies.

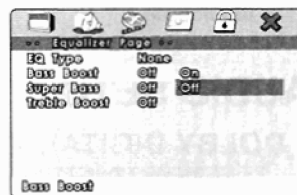

SUPER BASS

This function is more enhanced at low levels without distorting other frequencies.

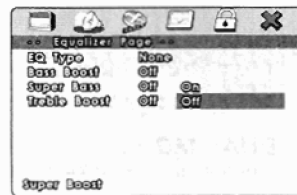

TREBLE BOOST

This function is enhanced at high levels without distorting other frequencies.

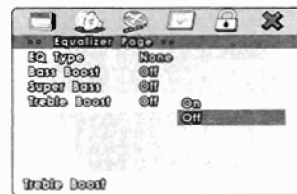

VIDEO SETUP

1. QUALITY

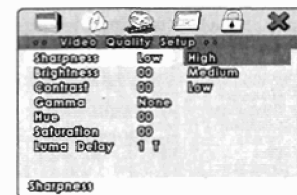
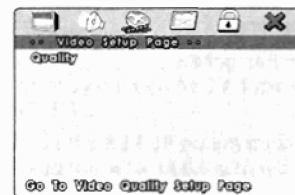

SHARPNESS

Use this option to select screen sharpness. Select screen sharpness using the direction $\blacktriangle/\blacktriangledown$ buttons and press the ENTER button.

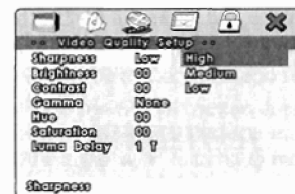

BRIGHTNESS

Use this option to select screen brightness. Adjust overall screen brightness using the direction $\blacktriangleleft/\blacktriangleright$ buttons and press the ENTER button.

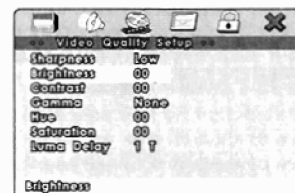

CONTRAST

Use this option to select screen contrast. Select screen contrast using the direction $\blacktriangleleft/\blacktriangleright$ buttons and press the ENTER button. Contrast adjusts the image quality by increasing or decreasing the ratio of bright and dark screen section.

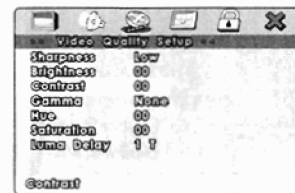

DVD Setup

GAMMA

Select screen gamma using the direction ▲/▼ buttons and press the ENTER button. Gamma adjustment is to revive the dark screen section by raising the level of dark section, while leaving the bright screen section unchanged.

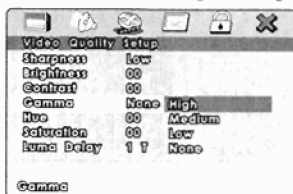

HUE

Select screen hue level using the direction ◀/▶ buttons and press the ENTER button.

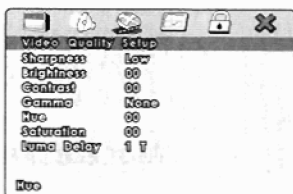

SATURATION

Select screen saturation level using the direction ◀/▶ buttons and press the ENTER button.

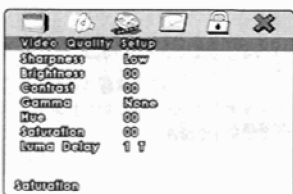

LUMA DELAY

Select the Luma Delay menu and select the preferred video image quality.

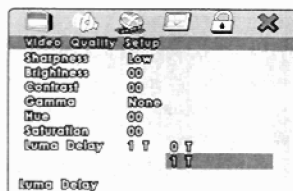

DVD Setup

■ PREFERENCE

This Menu is not available when play the disc.

1. TV Type

Choose a proper operating setting according to the color system of the TV Type - Multi system, NTSC, PAL.

- 1) Press the SETUP button during stop mode.
- 2) Press the ◀/▶ buttons to move to Preference.
- 3) Press the ▲/▼ buttons to move to TV Type.
- 4) Press the ENTER button.
- 5) Press the ▲/▼ buttons to select TV Type.

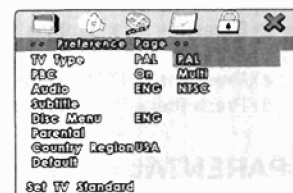

2. PBC (Play Back Control)

This feature is only available when a (Super) Video CD is loaded. It allows you to disable or enable the PBC(Play Back Control)menu of VCD discs.

- 1) Press the SETUP button during stop mode.
- 2) Press the ◀/▶ buttons to move to Preference.
- 3) Press the ▲/▼ buttons to move to PBC.
- 4) Press the ENTER button.
- 5) Press the ▲/▼ buttons to select On/Off.

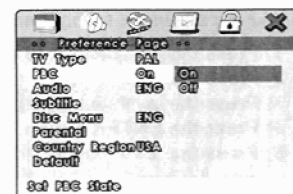

3. AUDIO

Use the audio language menu to select the subtitle language that you prefer. If the disc you are playing has that language available, it will display subtitles in that language.

- 1) Press the SETUP button during stop mode.
- 2) Press the ◀/▶ buttons to move to Preference.
- 3) Press the ▲/▼ buttons to move to Audio.
- 4) Press the ENTER button.
- 5) Press the ▲/▼ buttons to select desired audio language.

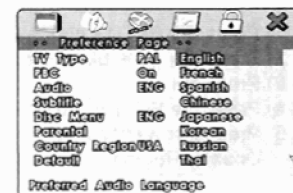

4. SUBTITLE

Use the subtitle language menu to select the subtitle language that you prefer. If the disc you are playing has that language available, it will display subtitles in that.

- 1) Press the SETUP button during stop mode.
- 2) Press the ◀/▶ buttons to move to Preference.
- 3) Press the ▲/▼ buttons to move to Subtitle.
- 4) Press the ENTER button.
- 5) Press the ▲/▼ buttons to select desired subtitle.

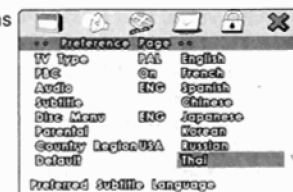

DVD Setup

5. DISC MENU

Use the Disc Menu option to select the language you want a DVD's disc menu to be displayed in (not the same as the player menu)

- 1) Press the SETUP button during stop mode.
- 2) Press the ◀/▶ buttons to move to Preference.
- 3) Press the ▲/▼ buttons to move to Disc Menu.
- 4) Press the ENTER button.
- 5) Press the ▲/▼ buttons to select Disc Menu.

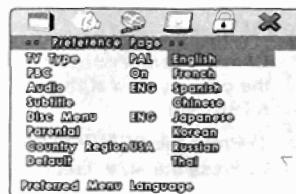

6. PARENTAL

The Parental feature is a rating limit system, like movie ratings. It works with DVD's that have been assigned a rating. This option lets you determine how your player will react to discs that contain movies that are rated (in the U.S.A., the Motion Pictures Association of America rates movies as G, PG, PG-13, ect.). You decide which ratings require a password and which ones don't.

- 1) Press the SETUP button when stop mode.
- 2) Press the ◀/▶ buttons to move to Preference.
- 3) Press the ▲/▼ buttons to move to Parental.
- 4) Press the ENTER button.
- 5) Press the ▲/▼ buttons to select desired parental level.

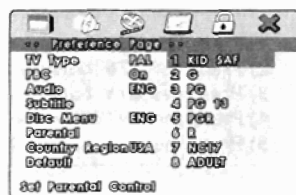

7. COUNTRY REGION

Use this menu function to change the COUNTRY REGION.

- 1) Press the SETUP button when stop mode.
- 2) Press the ◀/▶ buttons to move to Preference.
- 3) Press the ▲/▼ buttons to move to Country Region.
- 4) Press the ENTER button.
- 5) Press the ▲/▼ buttons to select desired Country Region.

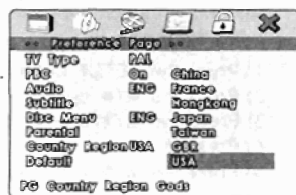

8. DEFAULT

If user selects reset from the setup menu, all the value of setup menu will be initialized by factory setting value. (Exception: Parental level, Region code and Password values will not be changed)

- 1) Press the SETUP button when stop mode.
- 2) Press the ◀/▶ buttons to move to Preference.
- 3) Press the ▲/▼ buttons to move to Default.
- 4) Press the ENTER button.
- 5) Press the ENTER button to select reset.

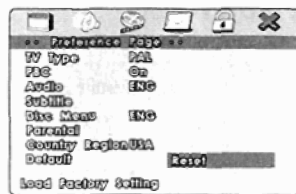

DVD Setup

■ PASSWORD SETUP

1. PASSWORD MODE



2. PASSWORD CHANGE

- 1) Select "Password Setup" sub item.
- 2) Enter your old password, and new password in 6 digits. (The default password code is 000000)
- 3) Re-enter new password for confirmation then press the ENTER button.

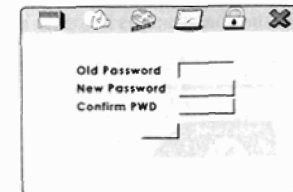

DVD Functions

EJECT

Each press of the EJECT button changes the play mode as the text to the right illustrates. When you insert your DVD disc into the DVD player, "DISC LOADING" will appear on the screen. Then the DVD disc is played automatically.

VOL+ / VOL-

To adjust the audio output level of the speaker from 0 to 20. (The volume cannot be adjusted in the AV mode.)

MUTE

Each press of the MUTE button changes the play mode.

OSD	CONDITION
Mute	Mute
Mute off	Mute Off

PLAY OR PAUSE

[DVD] / [AUDIO] / [MP3]

Use this button to select a particular scene or play the disc. Most DVD discs will play automatically.

OSD	CONDITION
PLAY	Play Disc
PAUSE	pause

AUDIO

[DVD]

Change the audio output type. (If the loaded disc supports available audio type)

OSD	CONDITION
1/2 : AC3 2CH English	2 Channel
2/2 : AC3 5.1CH English	5.1 Channel

[VCD] / [AUDIO]

Changes the audio output type. (If the loaded disc supports available audio type)

OSD	CONDITION
Stereo	Stereo
Mono Left	Mono Left
Mono Right	Mono Right
Mix Mono	Mix Mono

[MP3]

An invalid button press.

DVD Functions

STOP

[DVD]

Press the STOP button and stop the movie. And then Press the Play/Pause button and will display the last scene of the movie. Press the Stop button two times and stop the movie. And then Press the Play/Pause button and will display the first scene of the movie.

OSD	CONDITION
1 Time Press Play Key To Continue	Stop
2 Time Stop	Disc Stop

[AUDIO]/[MP3]

Press the STOP button and stop the Disc. And then Press the Play/Pause button and will display the first file of the Disc.

OSD	CONDITION
1 Time Stop	Stop

ARROWS

[DVD]

When display the DVD in ZOOM mode, can change the screen position by using ARROW button.

[AUDIO]

An invalid button press.

[MP3]

After pressing STOP button, select the desired folder and set the condition by pressing ENTER button.

SETUP

Use to set various functions according to your individual preference.

MENU

[DVD]

The menu of a DVD disc varies. The content of the menu on the screen is dependent on the particular DVD.

[AUDIO] / [MP3]

An invalid button press.

DVD Functions

DISPLAY

DISPLAY

[DVD]

Each press of the button DISPLAY on the remote control changes the play mode as follows:

OSD	CONDITION
Title 00/00 Chapter 000/000	Display title and chapter
Title Remain	Display title and chapter
Chapter Elapsed	Display the left title
Chapter Remain	Display the Chapter Elapsed
Display Off	No sign

[VCD]

Whenever press the button, title chapter will be displayed as follows:

OSD	CONDITION
Single Elapsed	Display time
Single Remain	Left display time
Display Off	No sign

[AUDIO]

Each press of the display button displays information about the current CD on the screen as follows:

OSD	CONDITION
Single Elapsed	Display the single elapsed
Single Remain	Display the single remain
Total Elapsed	Display the total elapsed
Total Remain	Display the total remain

[MP3]

Your DVD player will display the counter automatically when you play the MP3 disc.

NUMBER BUTTONS



[DVD]

The 0 through 9 number buttons are used to enter the number of the track, the number of the DVD chapter, time data, etc.

[AUDIO]

You can select a track by pressing the corresponding number button.

OSD	CONDITION
Select Track : __	Select track no

[MP3]

You can select a track in the folder by pressing the corresponding number button.

OSD	CONDITION
__ : __	Select track no

DVD Functions

SUBTITLE

SUB-T

[DVD]

This button is used to select the language for on-screen display messages. (The title menu is different, depending on the particular DVD.)

[AUDIO] / [MP3]

An invalid button press.

TITLE

TITLE

[DVD]

Used to display the title menu of the loaded DVD disc. (This function is disc-dependent.)

[AUDIO] / [MP3]

An invalid button press.

SLOW

SLOW

[DVD] / [VCD]

Used to play a disc in slow forward or slow reverse. This allows you to search forward three steps to reverse three steps to reverse three steps.
 slow forward play : press slow button.
 slow rewind play : press slow button and forward button again. (not in work VCD)

OSD	CONDITION
SF 2X	2X slow forward
SF 4X	4X slow forward
SF 8X	8X slow forward
SF 16X	16X slow forward
SR 2X	2X slow rewind
SR 4X	4X slow rewind
SR 8X	8X slow rewind
SR 16X	16X slow rewind
PLAY	play

[AUDIO] / [MP3]

An invalid button press.

DVD Functions

FAST REVERSE SEARCHING

[DVD]

Each press of the FR button changes the play mode as follows:

OSD	CONDITION
FR 2X	2X rewind search
FR 4X	4X rewind search
FR 8X	8X rewind search
FR 16X	16X rewind search
FR 32X	32X rewind search
PLAY	play

[AUDIO] / [VCD]

Each press of the FR button changes the play mode as follows:

OSD	CONDITION
FR 2X	2X rewind play
FR 4X	4X rewind play
FR 8X	8X rewind play
FR 16X	16X rewind play
FR 32X	32X rewind play
PLAY	play

[MP3]

Each press of the FR button changes the play mode as follows:

OSD	CONDITION
FR 2X	2X rewind play
FR 4X	4X rewind play
FR 8X	8X rewind play
FR 16X	16X rewind play
FR 32X	32X rewind play
PLAY	play

FAST FORWARD SEARCHING

[DVD]

Each press of the FF button changes the play mode as follows:

OSD	CONDITION
FF 2X	2X foward search
FF 4X	4X foward search
FF 8X	8X foward search
FF 16X	16X foward search
FF 32X	32X foward search
PLAY	play

[AUDIO] / [VCD]

Each press of the FF button changes the play mode as follows:

OSD	CONDITION
FF 2X	2X foward play
FF 4X	4X foward play
FF 8X	8X foward play
FF 16X	16X foward play
FF 32X	32X foward play
PLAY	play

[MP3]

Each press of the FF button changes the play mode as follows:

OSD	CONDITION
FF 2X	2X foward play
FF 4X	4X foward play
FF 8X	4X foward play
FF 16X	4X foward play
FF 32X	32X foward play
PLAY	play

DVD Functions

PREV

[DVD] / [VCD]

Used to move to the previous chapter from the current chapter.

[AUDIO] / [MP3]

Used to move to the previous track.

NEXT

[DVD] / [VCD]

Used to move to the next chapter from the current chapter.

[AUDIO] / [MP3]

Used to move to the next track from the current track.

REPEAT A-B

[DVD] / [VCD] / [AUDIO]

Press this button to repeat the selected segment. The selected segment will be repeated automatically until cancelled.

OSD	CONDITION
A	start point of repeat
A B	ending point repeat function

[MP3]

An invalid button press.

DVD Functions

REPEAT

[DVD]

Each press of the REPEAT button changes the play mode as follows:

OSD	CONDITION
Chapter	repeat chapter
Title	repeat title
All	all
	repeat off

[AUDIO]

Each press of the REPEAT button changes the play mode as follows:

OSD	CONDITION
Track	repeat single
All	all
	repeat off

[VCD]

An invalid button press.



[MP3]

Use to change the play mode. Each press of the REPEAT button changes the play mode as follows:

OSD	CONDITION
Repeat One	single
Repeat Folder	repeat folder
Folder	repeat folder one time
Shuffle	all
Random	random play
Single	single play

NTSC/PAL

Select the NTSC/PAL in condition of DVD mode.

ANGLE

Select "ON" for watching other camera angle. (This button can't control the preset camera angle.)

DVD Functions

PBC

[DVD] / [AUDIO] / [MP3]

An invalid button press.

[VCD]

You can turn the PBC (Play Back Control) function on or off by pressing this button. When PBC is loaded, the PBC function is enabled automatically. This function is similar as selection of DVD title. (not available with MP3)

ZOOM

[DVD]

Each press of the ZOOM button changes the play mode as the text to the right illustrates.

OSD	CONDITION
X 2	ZOOM x 2
X 3	ZOOM x 3
X 4	ZOOM x 4
X 1/2	ZOOM x 1/2
X 1/3	ZOOM x 1/3
X 1/4	ZOOM x 1/4
	Off

[VCD] / [AUDIO] / [MP3]

An invalid button press.

GOTO

When Watching DVD available to control the Menu.

Title

Move to the desired title.

Chapter

Move to the desired chapter.

Audio

Selects the desired audio output.

Subtitle

Select the desired subtitle.

Angle

Watch the different view angle.

TT Time

Total time.

CH Time

Chapter time.

Repeat

Sets the repeat play.

Time Display

Watch the condition of display.

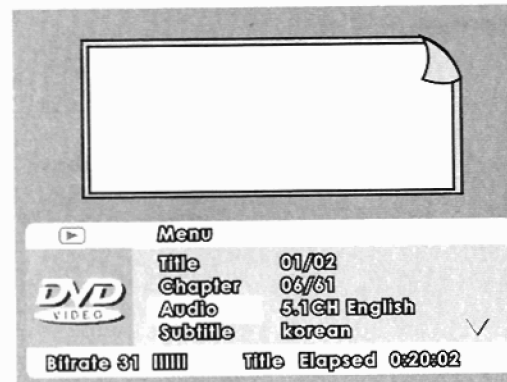

Installation

1. Unpack the color box and check the contents.

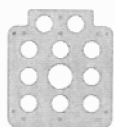

INSTALLATION PLATE



COMBO UNIT



SCREW

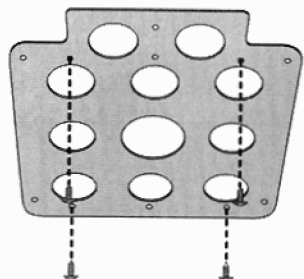

2. Match the position of installation bracket and installation plate with 4 screws.

3. Tighten the combo unit with the supplied 4 screws.

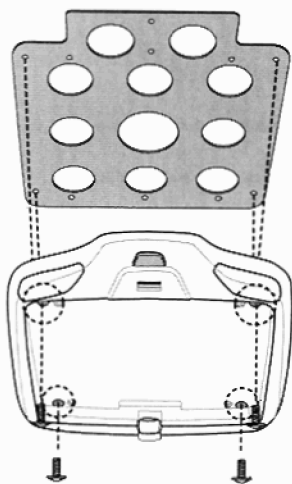

Connection Diagram

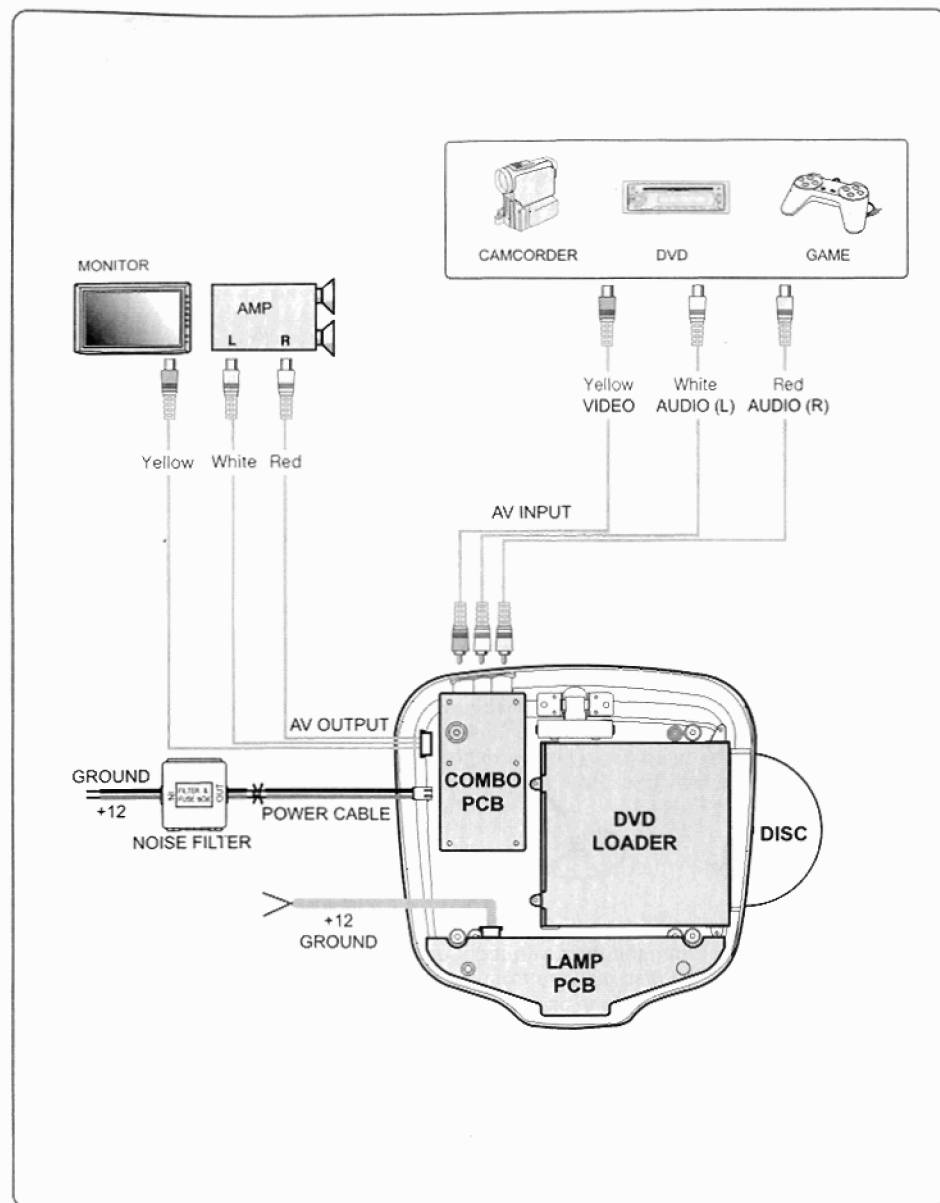

Disc Information

DVD features

DVD discs provide high-resolution images with high-quality sound and surround sound effects. This DVD player can play not only DVD discs of various versions, but also S-VCD, VDC, audio CD and MP3 discs. Each disc plays only the information saved on it, and some functions cannot be utilized.

Discs that cannot be played

DVD-RW, DVD-REM, CD-ROM, CD-EXTRA discs cannot be played on this unit. Also, a CD or a CD-RW which was recorded on special software cannot be played.

Region code

Your DVD player is designed and manufactured to region management information that is recorded on a DVD disc. Please check the region code.

1 : north America 2 : Japan 3 : Korea and Southeast Asia
4 : Australia, mid & south America 5 : Russia 6 : China

Copyright protection

This product incorporates copyright protection technology that is protected by methods claims of certain U.S. patents and other intellectual property rights owned by the Macrovision Corporation and other rights. Owner's use of this copyright protection technology must be authorized by the Macrovision Corporation, and is intended for home and other limited viewing uses only unless otherwise authorized by the Macrovision Corporation.

How to handle the disc

Don't touch the shiny side of the disc (the side with the embedded information).
Don't stick a label or a glue-based note on either side of the disc. Don't use discs that have glue or a damaged gluey label-it might result in damage to your DVD player.
Don't put discs in the sunshine. Park your car in the shade.



Caution

Wipe softly with a wet cloth and then with a dry one.
Before playback, wipe the disc outward from the center with a clean cloth.
Do not use any type of solvent such as thinner, benzene, commercially-available cleaners or antistatic spray.
To avoid damaging your DVD player, don't use a scratched disc.



Troubleshooting

Symptom	Items to Check	Actions to be Taken
Button does not work.	Is the power turned on?	Check the car battery capacity.
No sound	Is the audio which is connected with the audio cable set to receive the DVD signal output?	Select the correct input mode for the audio receiver.
	Is audio cable is connected securely?	Connect the audio cable into the jacks securely.
	Is the monitor which is connected with the audio cable turned on?	Turn on the monitor connected with the audio cable.
	Is the digital audio output set in the correct position?	Set the Digital Audio Output to the correct position, and then turn on the DVD player again by pressing the POWER button.
No picture	Is the monitor set to receive the DVD signal output?	Select the proper video input mode in the monitor and check to see if the DVD playback screen is displayed on the monitor.
	Is the video cable connected correctly?	Connect the video cable correctly.
	Is the monitor powered on?	Turn the monitor power on.
No playback	Is the disc incompatible?	Insert the compatible disc. (Check disc type, color type and area code)
	Is the disc put upside down?	Insert a disc with the playback side down.
	Is the disc contaminated with dust?	Clean the disc.
	Is the menu displayed on the monitor?	Press the function selection button to close the menu screen
Remote control does not work properly.	Is the rating level correct?	Cancel the parental function or change the parental level.
	Is the remote control facing at the remote sensor?	Point the remote control to the remote sensor of the product.
	Is the distance too far?	Use the remote control within 5m.
Unable to receive TV broadcasting.	Is there any obstacle in the middle?	Remove the obstacle.
	Is the battery exhausted?	Replace with new batteries.
	Is the antenna connected properly?	Check antenna connection.



Check point

When a disc is brought from a cold environment to a hot one, there may be steam on the face of the disc, or water will appear on the pickup lens. It will affect the play.

1. Remove the disc from the DVD player.
2. Turn on the power and leave it on for an hour to vaporize the condensation.
3. You can operate the DVD player without any problems.



Specifications

Power	DC 12V
Screen Format	4 : 3
Resolution	640(RGB) X 480 Pixel
Brightness	380 cd/m ²
Color System	NTSC / PAL Auto Selection
A/V Input	1 EA
A/V Output	1 EA
Screen Size	8 Inch
IR Transmitter	Yes
Remote Control	Yes
Dimension	11,25"(W) X 11,25"(D) X 1,92"(H)mm

Note : This equipment has been tested and found to comply with the limits for a Class A digital device, pursuant to part 15 of the FCC Rules. These limits are designed to provide reasonable protection against harmful interference when the equipment is operated in a commercial environment. This equipment generates, uses, and can radiate radio frequency energy and, if not installed and used in accordance with the instruction manual, may cause harmful interference to radio communications. Operation of this equipment in a residential area is likely to cause harmful interference in which case the user will be required to correct the interference at his own expense.