

Support site

If you have any questions or for the latest support information on this product, please visit the web site below:

<http://www.soundstream.com>

If you have any questions/problems regarding this product, try the following:

- 1 Read Troubleshooting in these Operating Instructions.
- 2 Please contact (U.S.A. only);
URL <http://www.soundstream.com>

<http://www.soundstream.com>

©2017 Soundstream Corporation Printed in USA

SOUNDSTREAM

AV Center

2 DIN 6.2" TFT Monitor
MP3/MP4 Player
AM/FM Radio
Support Bluetooth
Support Navigation
Support SiriusXM Ready

Owner's Manual EN

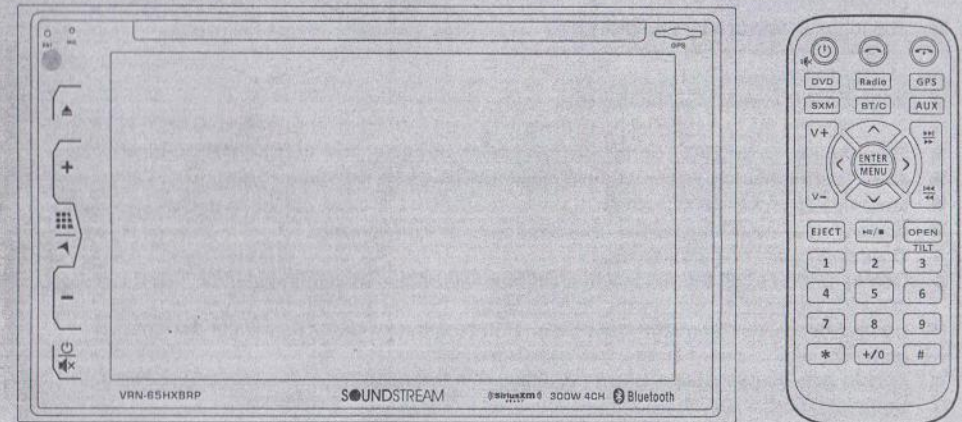

SiriusXM
READY

GPS

RDS
RADIO DATA SYSTEM

Bluetooth

AUX
INPUT



300W 4CH



VRN-65HXBRP

WARNING!

To promote safety, certain functions are disabled unless the parking brake is on. The Unit is designed to detect parked status and must be connected to the power supply side of the parking brake switch. Improper connection or use of this connection may violate applicable law and may result in serious injury or damage. To avoid the risk of damage and injury and the potential violation of applicable laws, this unit is not for use with a video screen that is visible to the driver.

- To avoid the risk of accident and the potential violation of applicable laws, the front Video image feature should never be used while the vehicle is being driven. Also, other video displays should not be in a location where it is a visible distraction to the driver. In some countries or states the viewing of images on a display inside a vehicle even by persons other than the driver may be illegal. Where such regulations apply, they must be obeyed and this unit's DVD features should not be used.
- Please remember to wear your seat belt at all times while operating your vehicle. If you are ever in an accident, your injuries can be considerably more severe if your seat belt is not properly buckled.
- The supplier waves any and all liability when these warnings are not followed.

OPERATION PRECAUTIONS







- Only connect to a 12VDC battery and negative grounding.
- Avoid placing the product in direct sunlight, in areas with high levels of dust, high temperatures (over 40°C) or high humidity (over 90%). In case of high temperatures, cool down the car interior by means of ventilation or air-conditioning.
- Operate in well ventilated areas.
- Do not turn on or off the product in short intervals. When turning the unit off, wait for at least 10 seconds prior to turning the unit on again. Do not operate the player with scratched, bent or broken discs and when a disc is not loaded properly, do not force it into the player.
- Do not watch video playback while driving which will cause serious danger and risks of traffic accident. It may violate the laws and regulations.
(There may be exceptional case, i.e., using rear view camera and navigation system)
- Do not install the unit where the operation for safety driving is restrained.
- Do not disassembly the unit by yourself, if need repairing, please take the unit to the after service center.
- Do not open and close the monitor manually, it may damage the monitor tilt system.
- Do not touch the LCD screen by hard objects, it may damage or give scratch to the LCD screen.
- If the back of monitor touches dashboard or air-conditioner inlet etc after open the monitor, then setup TILT level in monitor TILT menu to prevent damage from repeat touching.
- Car parking under direct sunlight may increase the temperature inside the car and the unit may not be in proper operation, please try it again after the temperature returns to normal.
- Do not replace the fuse on the power cable without professional guidance, using improper fuse may cause damage to the unit or even cause burn the unit.
- Do not use irregular shaped Disk.
- IR remote control operation may be hindered by monitor when the monitor is opened, thus please use the remote control at the similar level of remote control receiver.
- Do not install the unit where the cooling fan is blocked.

CONTENTS

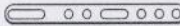
WARNING!	2
OPERATION PRECAUTIONS	2
CONTENTS	3
ACCESSORIES	4
UNIT INSTALLATION AND REMOVAL	5
WIRING CONNECTIONS	6
FRONT PANEL	8
REMOTE CONTROL	9
REMOVE BATTERY	11
MAIN MENU	12
◆ RADIO	12
◆ DVD PLAYER	13
◆ DISC/USB INTERFACE OPERATION	13
◆ SETTING CONTROL	14
◆ SOUND SETTING	15
◆ DISPLAY SETTING	15
◆ RADIO SETTING	15
◆ GENERAL SETTING FOR SiriusXM	15
◆ DVD SETTING	16
◆ STEERING WHEEL CONTROL	16
◆ SYSTEM	16
◆ SiriusXM SETTING	17
GPS SECTION	19
BLUETOOTH SECTION	20
AV-IN MODE	22
OTHER FUNCTIONS	22
NOTES ON DISC	23
TROUBLESHOOTING	24
TROUBLESHOOTING	25
TECHNICAL SPECIFICATIONS	26

ACCESSORIES

Package contains the following accessories for installation and operation of the unit.

(1) Washer, Spring Washer, M5 Nut	1 each	
(2) Metal Mounting Strap	1	
(3) Hex Bolt	1	
(4) Screw Max. 8mm (7/32 x max. 5/16 in)	4	
(5) Metal Mounting Sleeve	1	
(6) Release Key	2	
(7) Tapping Screw	1	
(8) Rubber Cushion	1	



Remote Control



User Manual



Warranty card

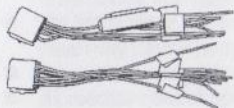

ISO cable

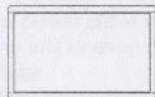

Plastic outer trim ring



MiniSD card (Map)



AAA Battery

Note:
Product image may vary from the actual delivery.

INSTALLATION / UN-INSTALLATION

Note

Before starting installation of the unit, make sure the wiring is connected properly. Use only the parts provided with the unit to ensure proper installation.

The use of unauthorized parts may cause malfunction.

Install the unit where it does not get in the driver's way and will not injure the passenger in case there is a sudden stop, like an emergency stop.

◆ INSTALLATION (Figure 1)

- ◆ Insert the unit into dash-board hole and fix it
- ◆ If necessary, place the mount strap at the rear of the unit and fix it with provided washer as figure 2.
- ◆ Place Trim Ring over the unit and installation is completed as figure 1.

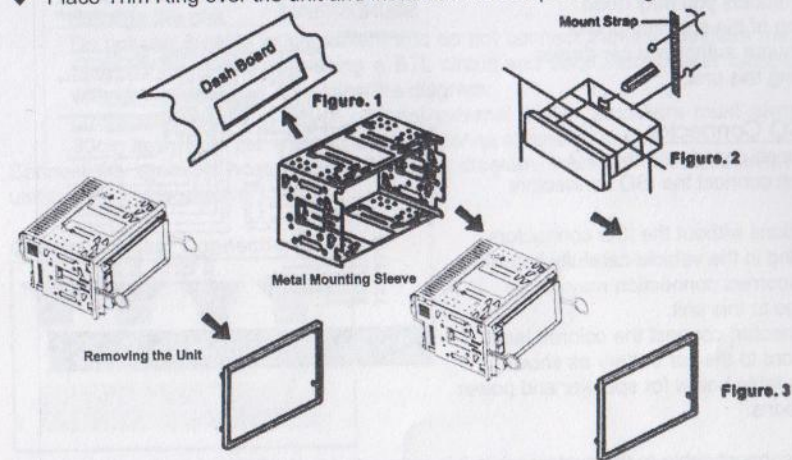

◆ Removing the Unit

Insert the supplied release key into the unit and pull the unit out with keeping the release key (As Figure. 4)

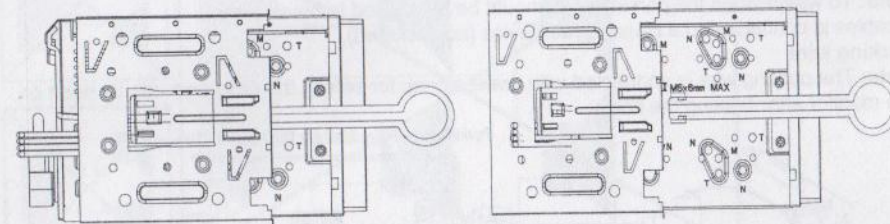

Figure 4

WIRING CONNECTIONS

Make sure you have good chassis ground. A good ground connection will eliminate most electrical noise problems. A good chassis ground requires a tight connection to the vehicle's metal chassis. The area around the ground connection should be clean, bare metal without rust, paint, plastic, dust, or dirt for a good electrical connection.

Caution: Do not interchange the connection of the wiring!!!

For some car models you may need to modify wiring of the supplied power cord. Contact your authorized car dealer before installing this unit.

Using the ISO Connector

1. If your car is equipped with the ISO connector, then connect the ISO connectors as illustrated.
2. For connections without the ISO connectors, check the wiring in the vehicle carefully before connecting, incorrect connection may cause serious damage to this unit.
3. Cut the connector; connect the colored leads of the power cord to the car battery as shown in the color code table below for speaker and power cable connections.

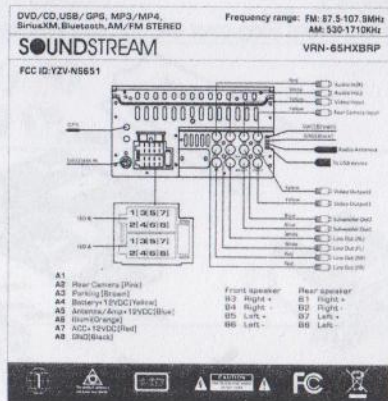

NOTE: Never connect cable to the system while it is connected to the battery power. Whenever the unit is disconnected from the battery, the preset memory will be erased and the unit will go back to its factory defaults.

When the brown cable for steering wheel control connected to the steering wheel, we can use the steering wheel to control some unit

Note: To watch video the parking wire should be connected to break signal. 2 cables is connected to a Hands-Free device (not included).

Parking wire

Note: The parking wire is connected with brake signal; for safety, the programs can be seen on the monitor after braking the car.

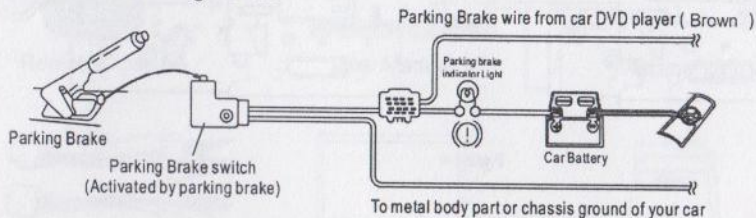

Connecting the reversing line to taillight on the car

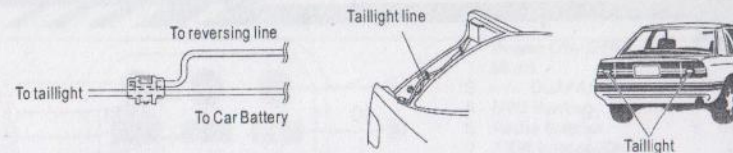

After connecting, when you start up the reverse gear, the unit will receive the picture from car rear view camera.

Note:

- Only use groundless loudspeakers.
- Use only loudspeakers of minimal 40Watt, using fewer watts may result in damaging your loudspeakers at higher volumes.
- Use 4~8 Ω (Ohm impedance) loudspeakers only; using higher or lesser impedance may damage the unit.
- Do not use 3-cable loudspeakers and do not connect the loudspeakers minus to the car body (GND). The unit is using a BTL circuit and each loudspeaker must be connected with insulated cables according the diagram.
- Loudspeaker cables and/or optional external power amplifiers must always be about 30cm away from the antenna and/or antenna extension parts.

Connect the speakers according the following diagram, incorrect connections will damage the unit or your loudspeakers

Correct Speaker Connection

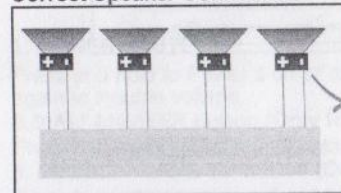

Incorrect Speaker Connection"

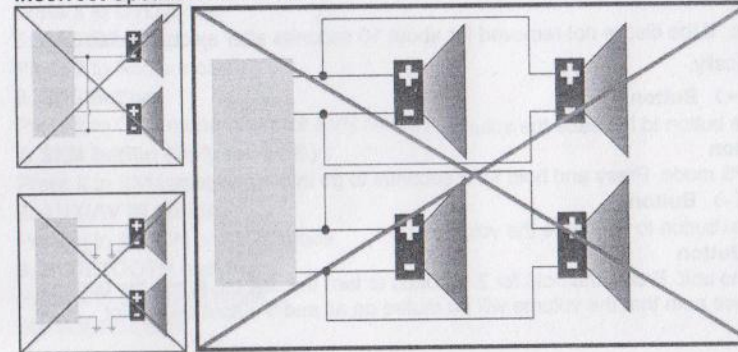

FRONT PANEL

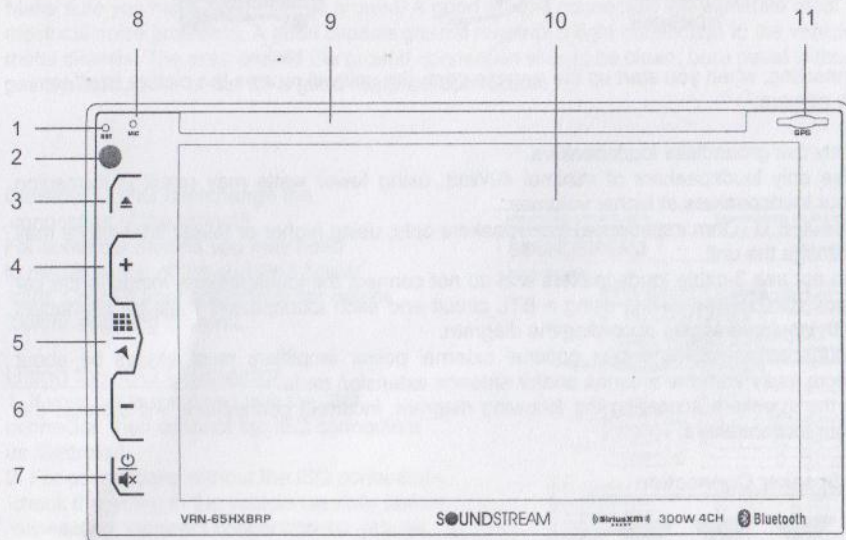

1. RESET Button

Press it with a thin, sharp object. The device will then be reset to factory default settings.

2. IR Sensor

IR Remote control signal receiving window.

3. EJECT Button

Press to eject a disc. If the disc is not removed for about 10 seconds after eject, the disc is reinserted automatically.

4. VOL Increase (+) Button

Press VOL increase button to increase the volume.

5. MENU/NAVI Button

Press it enter to GPS mode. Press and hold for 2 seconds to go into home page.

6. VOL Decrease (-) Button

Press VOL decrease button to decrease the volume.

7. POWER/MUTE Button

Press it to turn on the unit. Press and hold for 2 seconds to turn the unit off. Press the button briefly to Mute. Please note that the volume will be muted on all audio output connector.

8. MIC

9. DISC Slot

10. Info Display

Information Display LCD when operation the unit.

11. GPS Slot

REMOTE CONTROL

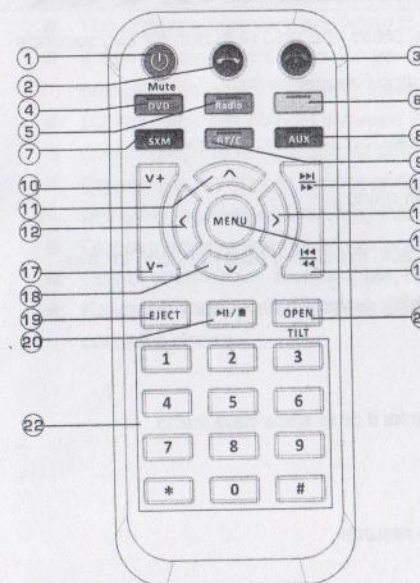

- | | |
|----------------------------------|--------------------------------------|
| 1 Power ON/OFF Mute | 3 Hang-up |
| 2 Dial/Answer | 6 GPS Button(Only for AVN model) |
| 4 DVD Button | 8 AUX Button |
| 5 Radio Button | 9 BT / Cancellation |
| 7 SXM Button(Only for SXM model) | 13 >>> /Fast Forward |
| 10 Volume + | 14 Right Arrow |
| 11 Up Arrow | 15 Menu/Ok |
| 12 Left Arrow | 16 <<< /Fast Review |
| 17 Volume - | |
| 18 Right Arrow | |
| 19 Eject | |
| 20 Play/Pause/Stop | 21 Open/Tilt(Only for Flip-up model) |
| 22 Number Key | |

Note:

- 1 GPS just for Navigation Model
- 2 SXM just for include SiriusXM function model
- 3 * # BT/C
- 4 OPEN/TILT Optional function

1. POWER / MUTE

Press and hold to Power it on or off. Short press this button to mute the volume output, press it again to resume volume.

2. DIAL/ ANSWER button (Only for Bluetooth)

Press to make a call after inputted a phone number or answer an incoming call.

3. REJECT / HANG UP button (Only for Bluetooth)

Press to reject a coming call or hang up while calling.

4. DVD button

Press it to DVD mode.

5. RADIO button

Press it to Radio mode.

6. GPS button

Press it to GPS mode.(Only for AVN model)

7. SXM button (Only for SXM)

Press it to SXM mode.

8. AUX/AV IN button

Press it to AUX IN or AV IN mode.

9. BLUETOOTH button

Press it to Bluetooth mode.

10. VOL+ button

Press to increase volume level.

11. Cursor ▲ buttons

Use the ▲ buttons to select the menu item, the title track or to show next frame.

12. Cursor ◀ buttons

Use the ◀ buttons to select the menu item. The title tracks it or to show next frame.

13. ►► / button

In DVD mode, Press ►► button to skip to the next track, press and hold ►► button for two seconds to activate fast forward(FF) in a track.

In RADIO mode, press to start manual searching ►► button Frequency up.

14. Cursor ◄ buttons

Use the ◄ buttons to select the menu item, the title tracks it or to show next frame.

15. MENU/ENTER button

Press it to confirm selection, Press and hold show main menu..

16. ◄◄ / button

In DVD mode, Press ◄◄ button to skip to the previous track. Press and hold ◄◄ button for two seconds to activate fast reverse(REW) in a track.

In RADIO mode, press and hold to start manual searching ◄◄ button Frequency down.

17. VOL- button

Press to decrease volume level.

18. Cursor ▼ buttons

Use the ▼ buttons to select the menu item. The title tracks it or to show next frame.

19. EJECT button

Press it to eject the disc.

20. PLAY/PAUSE/STOP button

In DVD mode, press it to stop playback, press again to resume.

21. OPEN/TILT Button

Press this Button to open and close the TFT monitor. WARNING: Do not obstruct the monitor while in the opening or closing cycle, this may cause damage to the monitor mechanism and is **NOT** covered under warranty.

Press and hold for 2 second to adjust the Monitor tilt angle: TILT ANGLE 1 => TILT ANGLE 2 => TILT ANGLE 3 => TILT ANGLE 4.

22. Digit 0-9 * # buttons

In radio mode, select 1-6 the desired band; In DVD mode, select track. In Bluetooth mode, 0-9 * # enter the phone number or input password.

REMOVE BATTERY

Note:

- The distance may vary according to the brightness of ambient light.
- If the remote is not used for an extended period of time, remove the battery to prevent possible damage from battery leakage and corrosion.
- Do not place any objects between the remote control unit and the sensor on the unit.
- Do not drop the remote control onto the floor; it will damage it beyond repair.
- Do not use the remote control unit, while simultaneously operating the remote control unit of any other equipment; they may interfere resulting in improper operation.
- Dispose empty batteries in accordance with your local governmental regulations.
- Do not short-circuit, disassemble, heat or dispose of fire or flames the battery.
- Keep the battery out of reach of children, should the battery be swallowed, immediately consult a doctor.

MAIN MENU

The best way to discover the program is to explore each screen in detail, and to find out how to move from one to another. Read this chapter for a guided tour. Unit starts by displaying the Main menu. This is the root of the screen hierarchy, and you can simply access all features by tapping on the touch screen buttons. Tap the icons to enter a desired mode.



RADIO PLAYER

To start Radio, tap RADIO button on main menu screen.



- Touch this button can choose FM1=>FM2=>FM3=>AM1=>AM2.
- Touch this icon to select station forward manually. Touch and hold this icon to select station forward automatically.
- Touch this icon to select station backward manually. Touch and hold this icon to select station backward automatically.
- Mute the sound.
- Touch it can choose User =>Flat =>Classic =>Pop =>Rock.
- Touch this button can scan the stations from 1-6, Long Touch it to save the stations with good reception automatically and scan each station for about 5 seconds.
- Touch this button to search forward stations.
- Touch this button to search backward stations.
- Touch this button to switch radio traffic service on or off.
- Touch this button to select program type.
- Touch this icon select stereo or mono sound reception.
- Touch this icon access to Camera mode directly.

Note: When a radio signal is not received, the default for ST / MO function, once received radio function automatically converted to ST.

DVD PLAYER

To start DVD Player, tap on DVD icon from main menu screen.

TOUCH SCREEN MENU

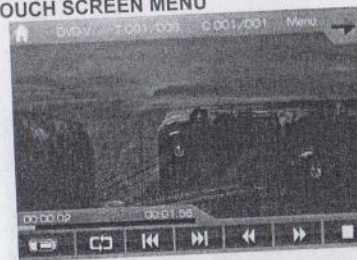

- In DVD mode, touch it can choose Repeat chapter =>repeat title =>repeat off. In VCD mode, touch it can choose Repeat REP 1 => REP DIR => REP ALL.
- Touch it to skip to the next track. Touch and hold for 2 seconds to activate fast forward (FF) search in a track.
- Touch it to skip to the previous track. Touch and hold for 2 seconds to retune to the beginning of the track.
- Press this button to fast reverse (REW) search in a track, FR×2×4×8×20-play will be display.
- Press this button to fast forward (FF) search in a track. FF×2×4×8×20-play will be display.
- STOP button.
- Touch it to enter to next page.
- Touch it to enter to menu.
- Touch it to select subtitle language.
- Touch it to select the sound channel: Stereo=>MONO L=> MONO R=>.
- Touch it repeatedly to change the viewing angle.
- In VCD mode touch it can choose PBC ON or OFF.
- Touch this icon access to Camera mode directly.

1. DVD Player will automatically start playing when you insert any DVD disc, MEMORY card or USB device.
2. Warning displays if the vehicle is moving for driver's safety.
3. DVD Player will not only play video, but also picture and music files as well.











◆ DISC/USB INTERFACE OPERATION

Disc

When a file disc, USB or a memory card is played, the screen will show following interface:

USB Device

To play MP3/ MP4/ WMA files from a USB flash memory, insert a USB flash memory into the USB port on the right side of the unit. The unit will play automatically MP3/MP4/WMA/JPEG files. Or repeatedly press the MODE button to select USB mode.

-  Touch this icon access to Camera mode directly.
-  Mute the sound.
-  Touch it to choose playing Music, Video and Picture files.
-  Touch it to pause/play.
-  Touch it to skip to the next track.
-  Press this button to fast reverse (REW) search in a track, FR×2×4×8×20-play will be display.
-  Press this button to fast forward (FF) search in a track. FF×2×4×8×20-play will be display.
-  Touch it to skip to the previous track.
-  Touch it to turn to the track you want to play. Input track number in the input box.
-  Touch it to enter TITLE MENU (you can choose music, picture and Video to play).
-  Touch it can choose User =>Classic=>Flat =>Pop =>Rock
And can adjust Bass, Middle and Treble.
-  Press it to activate the intro function.
-  Touch it to turn on / off random playback.
-  Touch it can choose Repeat REP 1 => REP DIR => REP ALL.
-  A-B segment repeat

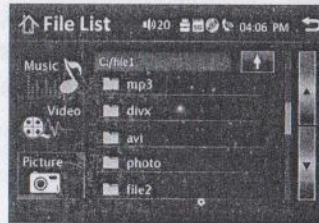
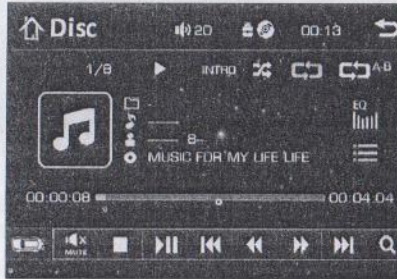

◆ SETTING CONTROL

To start SETTING, tap SETUP icon on main menu. Your device has default system settings. You can customize the settings to suit your personal needs. Once you change settings, your new settings will remain until you change it again

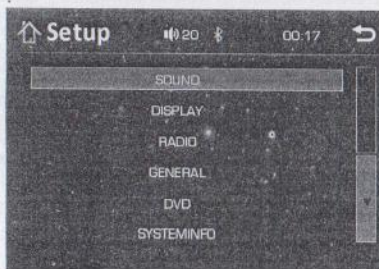

Sound



- EQ: User→Flat→Classic→Pop→Rock→User.
- BALANCE/FADER: Adjust the balance and fader to left or right.
- BEEP: Select keypad sound on or off.
- LOUD: Select loud on or off.
- LOUD LEVEL: Adjust the loud level
- SUBWOOFER: Turn subwoofer on or off.



- SUBWOOFER LPF:80HZ →120HZ→160HZ
- SUBWOOFER LEVEL: Adjust the subwoofer level
- GPS MIXING: Turn on or off.

Display



- BACK LIGHT: Adjust the screen backlight to LOW-MID-HIGH
- LCD COLOR:AUTO→Red→Yellow→Green→Cambridge Blue→Blue→Purple→White
- BACKLIGHT TIME:AUTO→OFF AFTER 10S→OFF AFTER 20S→OFF AFTER 30S

Radio



- RADIO AREA:Europe→USA→South America→Russia.
- STEREO: Turn on or off.
- LOCAL: Turn on or off.
- TA VOLUME: Adjust the TA Volume
- TA: Select TA on or off.

General setting for SiriusXM

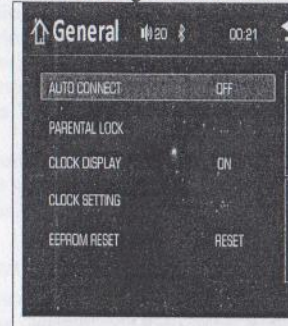

- AUTO CONNECT: Turn on or off.
- Parental Lock: Select Parental Lock to easily lock and unlock channels with mature content using Parental Control. The initial password is "0000".
- CLOCK DISPLAY: Select ON (clock is displayed on the screen) or OFF (clock is not displayed on the screen).
- CLOCK SETTING: Press number buttons to input the current time, and tap "OK" button save clock setting.
- EEPROM RESET: Select this to device will then be reset to factory default settings.

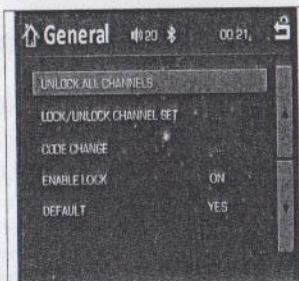

UNLOCK ALL CHANNELS: Select this to unlock all channels.

LOCK/UNLOCK CHANNEL SET: Select this to lock or unlock selected channels.

CODE CHANGE: Select this to change the parental lock code. The initial password is "0000". Follow the prompts to change the password.

DEFAULT: Select this to default the parental code back to the initial password of "0000".

DVD

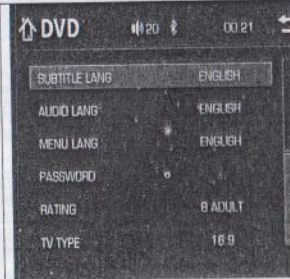

SUBTITLE LANG: English→French→Italian→Dutch→German→Spanish→Portuguese

AUDIO LANG: English→French→Italian→Dutch→German→Spanish→Portuguese

MENU LANG: English→French→Italian→Dutch→German→Spanish→Portuguese

PASSWORD: Set password.

RATING: 1kid safe→2G→3PG→4PG13→5PG-R→6R→7NC-17→8 adult

TV TYPE: Set TV type 4:3PS→4:3LB→16:9

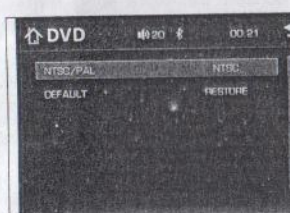

NTSC/PAL: Set NTSC or PAL

DEFAULT: Restore

System

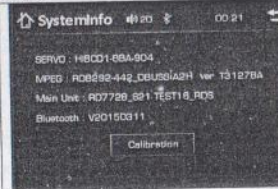

The software version is just for your reference.

SiriusXM Vehicle Tuner Connections

SiriusXM Satellite Radio operation required the connection of the SiriusXM-Connect Vehicle Tuner(sold separately).
 Note:The SiriusXM-Connect Vehicle Tuner must have the SiriusXM logo to be compatible with the VRN-65HXBRP.

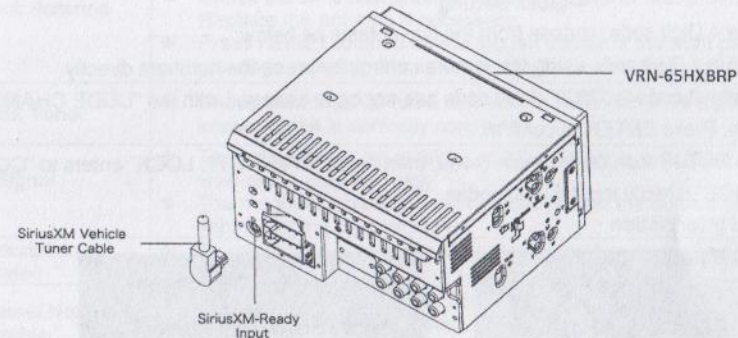

Line up the connector with the pins on the cable. It can only be inserted as shown above. Push the cable into the head unit's connector until it clicks. Attempting to insert the cable differently from shown above may cause damage to the cable or head unit.

SiriusXM SECTION

Before using SiriusXM, the head unit must be connected to the SiriusXM Connect Vehicle Tuner. After installing your SiriusXM Connect Vehicle Tuner and antenna, power on your head unit and tap the SXM icon on the main menu to enter SiriusXM mode. Only SiriusXM® brings you more of what you love to listen to, all in one place. Get over 140 channels, including commercial-free music plus the best sports, news, talk, comedy and entertainment. Welcome to the world of satellite radio. A SiriusXM Vehicle Tuner and Subscription are required. For more information, visit www.siriusxm.com.

Tuner Activation

To listen to SiriusXM Satellite Radio, a subscription is required. Activate the SiriusXM Vehicle Tuner using one of two methods below:
 1. Online: Go to www.siriusxm.com and choose ACTIVATE RADIO.
 2. Phone: Call SiriusXM Listener Care at 1-866-635-2349
 Activation typically takes 10-15 minutes, but may take up to an hour. It is recommended to leave your vehicle on until the 'Subscription Updated' message appears.

Radio ID

To view the Radio ID on the screen, please find channel 0 appears. The 8 character Radio ID will appear on the screen. The Radio ID is also printed on the underside of the SiriusXM Vehicle Tuner.

Note: The Radio ID does not use the letters I, O, S, F

Listening to SiriusXM Satellite Radio

After installation of the SiriusXM Vehicle Tuner, press SXM icon on the main menu enter to SiriusXM mode appears to begin listening to SiriusXM Satellite Radio.

SiriusXM Setup Menu

To access the SiriusXM setup menu options, please touch SETUP icon on the main menu, press General and then enter to SiriusXM setup.

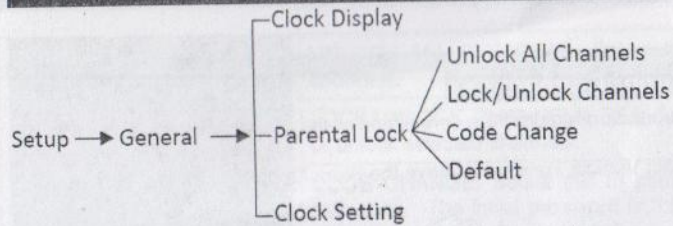

*To enter a 4 Digit code, choose from the two options as below:

- Enter the 4 Digit code using the remote control, by press the numbers directly. The default code is "0000" if the code has not been changed with the "CODE CHANGE" feature. Press ENTER to confirm.
- Touch SETUP icon on the main menu, then press "PARENTAL LOCK" enters to "CODE CHANGE" directly input 4 digit codes.

Displayed information

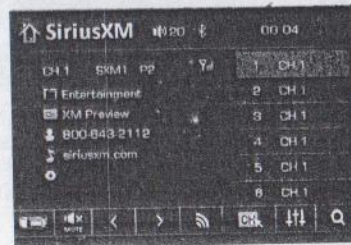
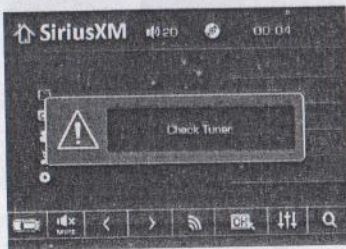

Touch this icon access to Camera mode directly.

Tap this icon to mute the sound.

Tap this icon to tune to the next channel.

Tap this icon to tune to the previous channel.

Tap this icon to select the bands SXM1, SXM2 and SXM3.

Tap this icon to direct tuning, it can scan channels.

Tap this icon to adjust tone equalizer between Users =>Classic=>Flat=>Pop=>Rock.

Tap this icon to display all channels in a selected category.

Note: The head unit supports direct tuning. When connected tuner, please tap the "CH" button on the menu, then input number to scan channels.

Search channel



SiriusXM Advisory Messages

Message	Description
Check Antenna	<ul style="list-style-type: none"> • Ensure the SiriusXM antenna cable is connected to the SiriusXM tuner correctly. • Check the SiriusXM antenna wire for breaks or sharp bends. Replace the antenna if necessary. • Press RESET located on the top left corner of the front panel. If the message remains, the antenna may have been damaged.
Check Tuner	<ul style="list-style-type: none"> • Check the SiriusXM tuner connection behind the VR-65XB to ensure that it is correctly connected.
No Signal	<ul style="list-style-type: none"> • The vehicle must be outside, and the antenna must have a clear view of the southern sky. • The magnetic antenna must be mounted on the outside of the vehicle for the best reception.
Subscription Updated	<ul style="list-style-type: none"> • An updated to your SiriusXM subscription has been received by the SiriusXM tuner. Touch any keys to continue.
Channel Not Available	<ul style="list-style-type: none"> • This channel is not a valid SiriusXM channel. The channel number has been entered incorrectly, or the channel was removed from the SiriusXM channel lineup.
Channel Not Subscribed	<ul style="list-style-type: none"> • This channel is not included in your SiriusXM subscription plan. Call 866-635-2349 or visit www.siriusxm.com to subscribe.
Channel Locked	<ul style="list-style-type: none"> • The selected channel has been locked by the parental control option. • A prompt to enter the unlock code will appear. Enter the unlock code as described on page 18.

GPS SCETION

To start GPS mode, please insert SD card in GPS slot on the front panel. Choose Navigation path and touch the Enter icon to enter the GPS (Navi path choose only for first using). You can choose road and run GPS.

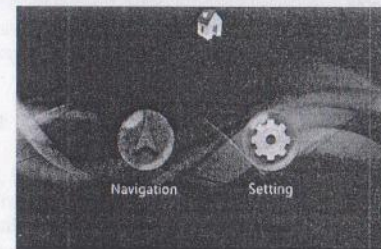

GPS Menu

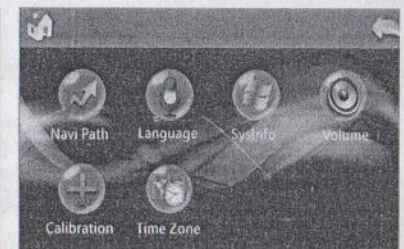

Enter the Navi Path



Choose Map

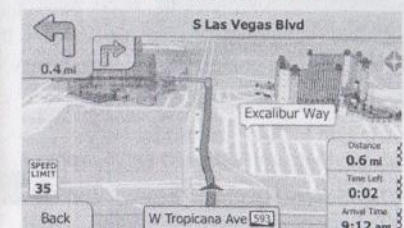

Enter the GPS

BULETOOTH SCETION

Warning: Driving and having a Telephone conversation at the same time is dangerous, please park your car before having a telephone conversation. The supplier waves any and all liability when this warning is not followed.

To enter Bluetooth mode, you can tap Bluetooth icon on Main menu or long press the mute/Bluetooth button on the Remote Control or press mode button on remote or on front panel.

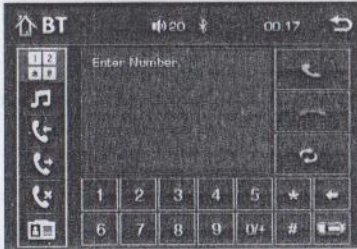

A user can make own choice by tap the buttons.

- Tap Dial button to enter call mode.
- Tap Music button to start Bluetooth Music player.
- Tap In calling button to check received calls.
- Tap Out calling button to check dialed calls.
- Tap Missed calling button to check missed calls.
- Touch this icon access to Camera mode directly.
- Tap Phone Book button to use phone book functions.
- Tap this icon translate Bluetooth to mobile mode.
- Tap this icon to clear number.
- Tap this button Hand up and reject calling.
- Tap this button Making and accept calling.

Pairing Mode

At the 1st time when using BLUETOOTH, you need to pair the mobile phone first. When a phone have not been paired with the unit, the BT icon and Pairing mark will blink continually on the panel.

When the unit have connect with phone, the BT icon will turn on and the Mobile phone name (if available) will be display on the panel.

According to mobile pairing device manual, after searching new device (SoundStream), select it, input password "0000" and confirm ok, device paring is finished.

The text 'Enter Number' will shows on the panel after the pairing is completed.

It means device is connected and ready for BLUETOOTH communication.

Auto-connect - Disconnect

When power on the unit, the last paired phone will be connected to the device via Bluetooth automatically, after searching about one minute, if the device cannot find the paired phone, it will stop searching. When in standby mode (unconnected), long press Bluetooth button on remote control to active auto-connect function and the device will search the last paired phone. If you want to disconnect the Bluetooth connection, turn off the Bluetooth on the phone.

1. Dial BUTTON

Tap on Dial button to enter call mode.

In Call mode, the unit can be used as your phone. Making and receiving calls are possible with

BLUETOOTH. Simply tap phone number and tap button to make a call, and tap button to hang up.

1.) Tap button shortly to delete a wrong digit, or press Reject/INT button on remote to delete all the numbers at once.

2) Tap button the device automatically makes a call to the latest call in its call log.

Voice Transfer

During a call, you can change a call from Bluetooth mode to phone by tapping Transfer button.

To have a call in Bluetooth mode again, tap Transfer button.

NOTE: the phonebook only supports Western Characters. Any difference in character will be shown such as "+, * or #"

2. (A2DP) Music Mode

Tap Music button to listen music in Bluetooth mode.

You can select the function with the key for previous, play or pause, stop and next.



A2DP (Advanced Audio Distribution Profile) Music Player

A2DP is a function which can receive the audio frequency signal from the mobile phone, amplified by the car audio and played out by the car speakers.

Notice: your mobile phone need to support A2DP.

Tap the buttons on the screen as shown, or press corresponding buttons (PAUSE/PLAY, STOP, PREVIOUS/NEXT) on remote control to play, pause, play previous, or next music file.

3. In calling/Out calling mode

Tap In calling button or Out calling to see received and dialed calls. The unit can download automatically all the date from the mobile Phone. Dialed/Received/Missed calls are saved In History mode. Tap Up/Down arrow load previous/next history record. The calls in each category are saved from the latest one to the final one. Select a number and tap Send button to enter calling mode.

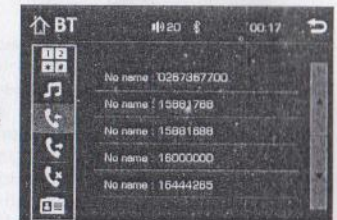

4. BT PHONE BOOK

The unit can download the data from phone, when the pairing between a phone and the unit automatically completed. The unit displays the data which have been downloading from a phone. Select a number and tap Send button to make a calling.

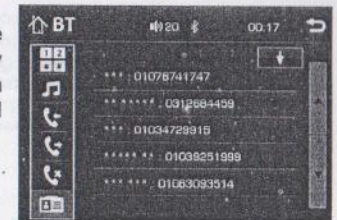

AV IN MODE

To start AV-IN Mode, tap on AV-IN button from main menu screen. Connect the external audio/video signal source to this unit. Select AV-IN mode in the main menu.

OTHER FUNCTIONS

Subwoofer

Connect the subwoofer to the unit using sub output (see electrical diagram). Tap MENU on screen enter into main menu setting choose setting menu. Choose SOUND and set subwoofer ON to enable subwoofer.

Parking

When the car is stopped and the parking brake is working, the screen can display the video image, otherwise the screen can't display the video image

Rear View Camera

This  button in UI is a Shortcut to the rear camera mode.

This unit is equipped with rear view camera output. The camera is used to observe the situation behind the vehicle when you are backing the car.

Please connect your rear view camera with the rear view camera input. And connect the reverse wire for back a car with the rear gear light. Rear view camera picture will be enabled when you are backing the car.

NOTES ON DISC

- ❖ Only use groundless loudspeakers.
- ❖ Use only loudspeakers of minimal 40Watt, using fewer watts may result in damaging your loud speakers at higher volumes.
- ❖ Use 4~8 Ω (Ohm impedance) loudspeakers only; using higher or lesser impedance may damage the unit.
- ❖ Do not use 3-cable loudspeakers and do not connect the loudspeakers minus to the car body.
- ❖ (GND). using a BTL circuit and each loudspeaker must be connected with insulated cables according the diagram.
- ❖ Loudspeaker cables and/or optional external power amplifiers must always be about 30cm. away from the antenna and/or antenna extension parts.
- ❖ If want to display for 7" TFT, parking wire must be connected to ground.

Handling discs

Handling

When holding
With both hands



When holding
with one hand



- Do not use damaged (cracked or warped) discs.
- Do not scratch the signal surface or let it get dirty.
- Do not attach paper or seals to discs. The player may be damaged if there is any exposed glue, etc., on discs. For rental discs in particular, extra labels are often attached to the discs. Check carefully for any exposed glue before using such discs.

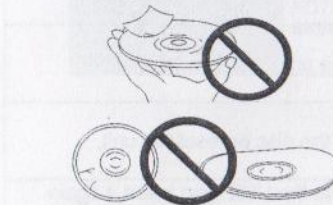

Storing discs

- Always place discs in their case and store them vertically. Avoid storing discs in hot or humid places, places exposed to direct sunlight and places in which the temperature is extremely low.
- Read any cautions included with the discs carefully.

Cleaning discs

- Fingerprints or dust on discs may reduce sound or picture quality. Remove them by gently wiping the disc from the center toward the edges using a soft cloth.

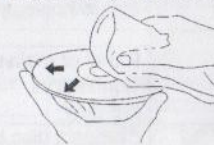

- Do not use benzene, thinner or other volatile chemicals. Do not use record spray or antistatic spray either.
- We recommend using the separately sold cleaning set to clean discs.
- For tough dirt, apply some water to a soft cloth, wring out thoroughly, wipe off the dirt, then wipe the disc with a dry cloth.

Irregular shaped discs
Irregular shaped discs (heart-shaped discs, hexagonal discs, etc.) cannot be played on this player. Doing so could damage the player. Never use such discs.



TROUBLESHOOTING

	Symptom	Cause	Remedy
General	Power does not turn on. (No sound is produced.)	Fuse is blown	Replace with fuse of the same amperage. If the fuse blows again, consult your store of purchase
		In correct wiring	Consult your local retailer.
	No sound output when operating the unit with amplifiers or power antenna attached.	Power antennal lead is shorted to ground excessive current is required or remote on the amplifiers or power antenna.	1. Turn off the unit. 2. Remove all wires attached to the power antenna lead. Check each wire for a possible short to ground using an ohm meter. 3. Turn on the unit. 4. Reconnect each amplifier remote wire to the power antenna lead one by one. If the amplifiers turn off before all wires are attached, use an external replay to provide remote-on voltage (excessive current required).
	Nothing happens When buttons are pressed. Display is not Accurate	The microprocessor has malfunctioned due to noise, etc.	Turn off the power, Then press the [no open] button and remove the DCP. Press the reset button for about 2 seconds with a thin rod.
		Panel or main unit Connectors are dirty	Wipe the dirt off with a soft cloth moistened with cleaning alcohol.
	CD	Sound is bad directly after power is turned on.	Compact disc is dirty
Compact disc is heavily scratched or warped			Replace with a compact disc without scratches.
Sound is bad directly after power is turned on.		Water droplets may form on the internal lens when the car is parked in a humid place	Let it dry for about 1 hour with the power on.
LCD	Small LCD display error message	When deck mechanism error, show ERROR 1	Reset the unit.
		When disc or servo error, it show ERROR 2	Change the disc or reset the unit.
		When USB error, t show ERROR 3	1.Remove the USB and insert it again 2. File error, please check the file. 3. Reset the unit.

TROUBLESHOOTING

SYMPTOM	CAUSE	SOLUTION
NO POWER	THE CAR IGNITION IS NOT ON.	IF THE POWER SUPPLY IS PROPERLY CONNECTED TO THE CAR ACCESSORY SWITCHES THE IGNITION KEY TO "ACC".
	THE FUSE IS BLOWN.	REPLACE THE FUSE.
DISC CANNOT BE LOADED.	PRESENCE OF DISC INSIDE THE PLAYER	REMOVE THE DISC IN THE PLAYER THEN PUT A NEW UPWARD.
DISC CANNOT BE READ.	INSERTING THE DISC IN UPSIDE DOWN.	INSERT THE COMPACT DISC WITH THE LABEL FACING UPWARD.
	COMPACT DISC IS EXTREMELY DIRTY OR DEFECTIVE.	CLEAN THE DISC OR TRY TO PLAY A NEW ONE.
	TEMPERATURE INSIDE THE CAR IS TOO HIGH.	COOL OFF UNTIL THE AMBIENT TEMPERATURE RETURNS TO NORMAL.
NO SOUND	VOLUME IS IN MINIMUM.	ADJUST VOLUME TO A DESIRED LEVEL.
	WIRING IS NOT PROPERLY CONNECTED.	CHECK WIRING CONNECTION.
THE OPERATION KEYS DO NOT WORK.	THE BUILT-IN MICROCOMPUTER IS NOT OPERATING PROPERLY DUE TO NOISE. FRONT PANEL IS NOT PROPERLY FIXING INTO ITS PLACE.	PRESS THE POWER BUTTON FOR ABOUT 10 SECONDS TO RESET THE UNIT.
SOUND SKIPS.	THE INSTALLATION ANGLE IS MORE THAN 30 DEGREES.	ADJUST THE INSTALLATION ANGLE TO LESS THAN 30 DEGREES.
	THE DISC IS EXTREMELY DIRTY OR DEFECTIVE.	CLEAN THE COMPACT DISC/TRY TO PLAY A NEW ONE.
THE RADIO DOES NOT WORK, THE RADIO STATION AUTOMATIC SELECTION DOES NOT WORK.	THE ANTENNA CABLE IS NOT CONNECTED THE SIGNALS ARE TOO WEAK.	INSERT THE ANTENNA CABLE FIRMLY SELECT A STATION MANUALLY.

TECHNICAL SPECIFICATIONS

General	
Power supply:	11~16V DC
Current consumption:	max. 10 A
Maximum power output:	52W x 4 channels (max)
Compatible formats:	DVD/ VCD/ MP3/MP4/VIDEO /CD/CD-R/-RW/DVD±R/±RW/PICTURE PLAYBACK
Dimensions (W x D x H) / weight:	178*165*100 mm/2 kg
Working temperature range:	-10°C - +60°C
ESP function:	10 sec. for Audio CD, 120 sec. for MP3
TFT display	
Screen size:	6.2 inch
Resolution:	800*480 pixel
Aspect ratio:	4:3/16:9
Brightness:	400 cd/m ²
FM Stereo Radio	
Frequency Range (EUROPE AREA):	87.5 – 108MHz (Step 50KHz)
Frequency Range (SOUTH AMERICA AREA)	87.5 – 108MHz (Step 100kHz)
Frequency Range (RUSSIA AREA)	87.5 – 108MHz (Step 50KHz) 65-74MHz (Step 10KHz)
Frequency Range (U.S.A. AREA):	87.5 – 107.9MHz (Step 200KHz)
Preset memory stations:	18
AM/MW Radio	
Frequency Range (EUROPE AREA):	522kHz - 1620 KHz (Step 9KHz)
Frequency Range (SOUTH AMERICA AREA)	520kHz - 1710 KHz (Step 10KHz)
Frequency Range (RUSSIA AREA)	522kHz - 1620 KHz (Step 9KHz)
Frequency Range (U.S.A. AREA)	530kHz - 1710 KHz (Step 10KHz)
Preset memory stations:	12
Audio Specification	
Frequency response:	20 Hz-20 KHz
USB interface	
USB type	USB 2.0 full speed
Support format	MP3 , WMA, Mpeg1, Mpeg2, AVI

Specifications are subject to change without notice. Mass and dimension are approximate.