

SOUNDSTREAM



OWNER'S MANUAL

EGA300.2X / EGA400.2X / EGA500.2X

EGA700.2X / EGA1000.2X

EGA560.4X / EGA680.4X / EGA1000.4X

EGA530.5X / EGA1000.5X



TABLE OF CONTENTS

INTRODUCTION	2
FEATURES & SPECIFICATIONS	3
CONTROLS & FUNCTIONS	4~12
EGA300.2X/400.2X/500.2X/700.2X	4
EGA1000.2X	5
EGA560.4X/680.4X/1000.4X/530.5X	5
EGA1000.5X	13
PLANNING & MOUNTING YOUR SYSTEM	13
WIRING DIAGRAMS	14~18
EGA300.2X/400.2X/500.2X/700.2X/1000.2X	14
EGA560.4X/680.4X/1000.4X	15~16
EGA530.5X/1000.5X	17~18
ADJUSTING & TUNING	19
TROUBLE SHOOTING	20



INTRODUCTION

Amplifiers provide high-performance sound reinforcement for your mobile audio equipment. The Multi-Mode bridging capabilities allow flexibility in hosting several different speaker configurations.

To achieve optimum performance, it is highly recommended that you read this Owners Manual before beginning installation.

FEATURES

- Fully regulated MOSFET power supply
- PWM circuitry
- Tri-guard amplifier protection
- IDI™ (Intelligent Distress Indicator) gives a visual indication of the amplifiers protection status
- Platinum RCA inputs and outputs
- Bi-linear selectable crossover for inputs and outputs (Hi/Full/Low)
- Continuously variable high and low-pass crossover
- Subwoofer equalizer control switch
- Variable phase shift control (0° ~ 180°)
- OEM floating ground input
- Platinum 4-gauge power connectors
- Tri-mode operation
- Optional remote bass boost control (EGA-RM)

Specifications

MODEL	NO. OF CHANNELS	RMS @ 4 OHM	@ 2 OHM	@ 4 OHM (BRIDGE)	FUSE	DIMENSIONS
EGA300.2X	2	75 x 2	150 x 2	300 x 1	25A x 1	11" x 2.4" x 9.8"
EGA400.2x	2	100 x 2	200 x 2	400 x 1	15A x 2	11" x 2.4" x 11"
EGA500.2X	2	125 x 2	250 x 2	500 x 1	20A x 2	11" x 2.4" x 14.6"
EGA700.2X	2	175 x 2	350 x 2	700 x 1	30A x 2	11" x 2.4" x 16.5"
EGA1000.2X	2	250 x 2	500 x 2	1000 x 1	30A x 3	11" x 2.4" x 19.7"
EGA560.4X	4	70 x 4	140 x 4	280 x 2	25A x 2	11" x 2.4" x 16.1"
EGA680.4X	4	85 x 4	170 x 4	340 x 2	30A x 2	11" x 2.4" x 17.3"
EGA1000.4X	4	125 x 4	250 x 4	500 x 2	30A x 3	11" x 2.4" x 19.7"
EGA530.5X	5	35 x 4 +125 x 1	70 x 4 +250 x 1	140 x 2 +200 x 1	20A x 2	11" x 2.4" x 19.7"
EGA1000.5X	5	75 x 4 +200 x 1	150 x 4 +400 x 1	300 x 2 +300 x 1	30A x 3	11" x 2.4" x 22"

Controls & Functions

EGA300.2X/400.2X/500.2X/700.2X

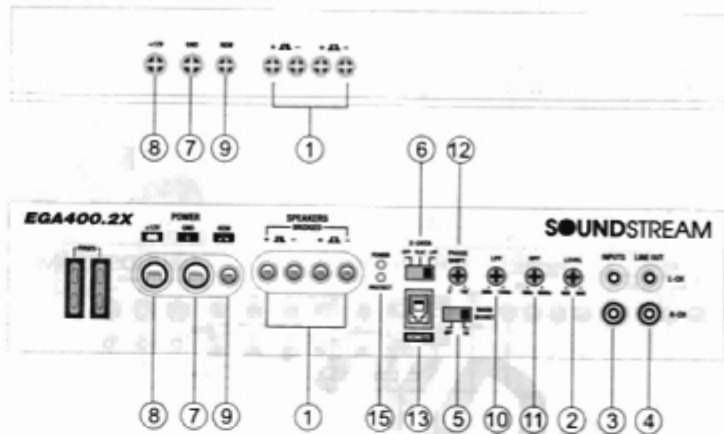

EGA1000.2X

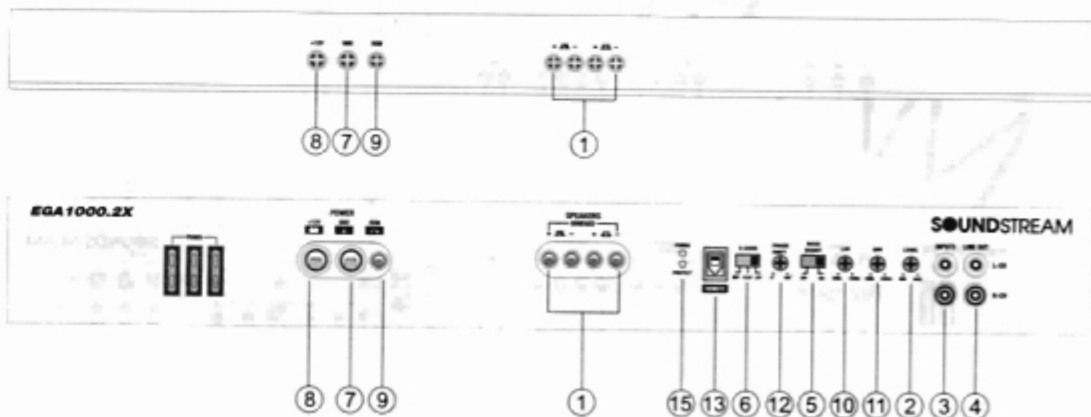

Controls & Functions

EGA560.4X/680.4X/1000.4X

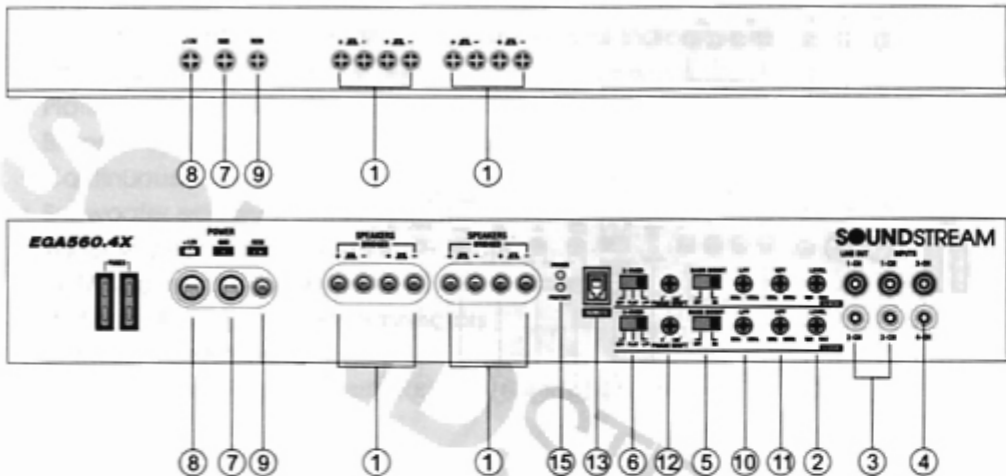

EGA530.5X

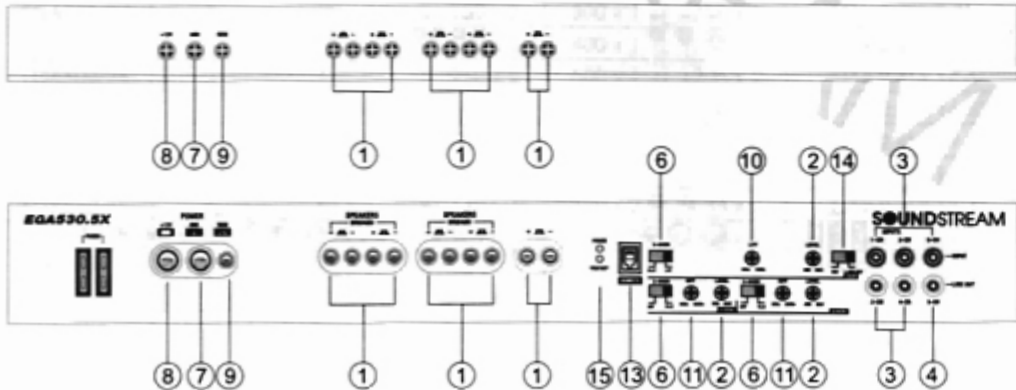

Controls & Functions

EGA1000.5X

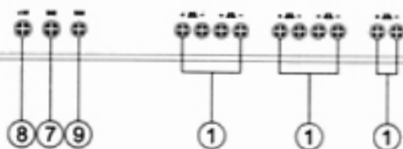

EGA850.5X

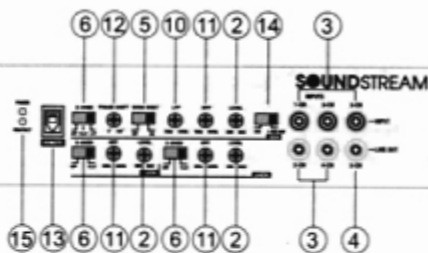
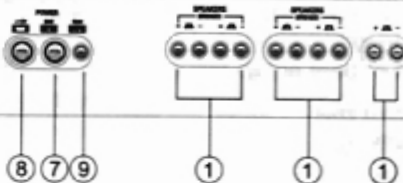

Controls & Functions

1. Speaker terminals

TOP



TOP



TOP



FRONT



EGA300.2X/400.2X/500.2X
EGA700.2X/1000.2X

FRONT



EGA560.4X/680.4X/1000.4X

FRONT



EGA530.5X/1000.5X

2. Input Sensitivity Adjustment

LEVEL



MIN MAX

EGA300.2X/400.2X/500.2X
EGA700.2X/1000.2X/560.4X
EGA680.4X/1000.4X
EGA530.5X/1000.5X

This control adjusts the amplifier's input sensitivity. Input sensitivity is variable from 200 Millivolts to 8 volts. Clockwise increases sensitivity. Counterclockwise decreases sensitivity. The amplifier can be driven to full power with a wide range of signal levels. A lower signal level will require increased sensitivity for full power. A higher signal level will require decreased sensitivity. Avoid setting sensitivity lower than necessary as this would introduce unwanted distortion.

3. Low Level Input RCA jacks

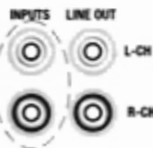

EGA300.2X/400.2X/500.2X
EGA700.2X/1000.2X

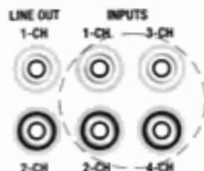

EGA560.4X/680.4X/1000.4X

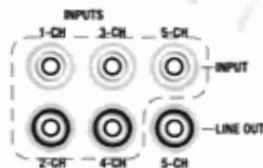

EGA530.5X/1000.5X

These inputs are for signal cables from the source. Always use high quality shielded RCA cables.

Controls & Functions

4. Low Level OUT RCA jacks

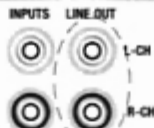

EGA300.2X/400.2X/500.2X
EGA700.2X/1000.2X

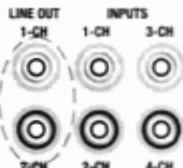

EGA560.4X/680.4X/1000.4X

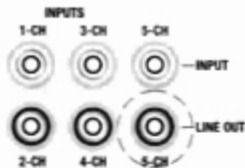

EGA530.5X/1000.5X

The LINE OUT allows you to build multiple amplifier systems without having to use splitter cords to distribute the signal. Now it is simply a matter of bringing one set of RCAS into the first amplifier, then using the line out RCA jacks as the feed to the next amplifier.

5. Bass Boost Switch

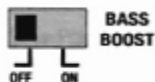

EGA300.2X/400.2X/500.2X
EGA700.2X/1000.2X

BASS BOOST



BASS BOOST



EGA560.4X/680.4X/1000.4X

BASS BOOST



EGA1000.5X

By using the bass boost function, bass notes at 35Hz - 80Hz are emphasized as much as 10dB.

6. X-over Switch

X-OVER



EGA300.2X/400.2X/500.2X
EGA700.2X/1000.2X

X-OVER



X-OVER



EGA560.4X/680.4X/1000.4X

X-OVER



CH 5



CH 1/2



CH 3/4

EGA530.5X

X-OVER



CH 5



CH 1/2



CH 3/4

EGA1000.5X

Adjust the crossover for your chosen installation method.

- LOW : Low pass filter-only bass tones (50Hz-150Hz) go to speakers. Use with woofer or sub-woofer.
- FULL : No filter-all tones go to speakers. Use with full-range speakers, or with external crossovers.
- HIGH : High pass filter-blocks very low tones (50Hz-600Hz) from the speakers.

Controls & Functions

7. B-Terminal (Chassis ground)

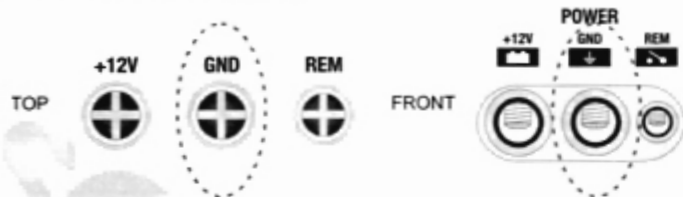

EGA300.2X/400.2X/500.2X
EGA700.2X/1000.2X/560.4X
EGA680.4X/1000.4X
EGA530.5X/1000.5X

To avoid unwanted ignition noise caused by ground loops, it is essential that the Amplifier be grounded to a clean, bare, metal surface of the vehicles chassis.

Note : GROUND WIRE SHOULD NOT BE EXTENDED MORE THAN 3 FT (1 METER).

8. B+ Terminal (Battery positive)



EGA300.2X/400.2X/500.2X
EGA700.2X/1000.2X/560.4X
EGA680.4X/1000.4X
EGA530.5X/1000.5X

Due to the power requirements of the Amplifier, this connection should be made directly to the positive(+) terminal of battery. For safety measure, install an in-line fuse Holder (not included) as close to the battery positive(+) terminal as possible with an ampere rating not to exceed total value of fuses in Amp.

9. Remote Power On



EGA300.2X/400.2X/500.2X
EGA700.2X/1000.2X/560.4X
EGA680.4X/1000.4X
EGA530.5X/1000.5X





Controls & Functions

To remote wire car stereo.

This amplifier is turned "ON" remotely when vehicle's stereo is turned "ON"







Note : IF YOUR RADIO DOES NOT HAVE +12 VOLT OUTPUT LEAD WHEN TURNED ON, THE "REMOTE" TERMINAL ON THE AMPLIFIER CAN BE CONNECTED TO VEHICLES ACCESSORY CIRCUIT WHICH PROVIDES +12V WHEN THE CAR IS ON.

10. Low Pass Filter Control

<p>LPF</p>  <p>50Hz 150Hz</p> <p>EGA300.2X/400.2X/500.2X EGA700.2X/1000.2X</p>	<p>CH 1/2</p> <p>LPF</p>  <p>50Hz 150Hz</p> <p>CH 3/4</p> <p>LPF</p>  <p>50Hz 150Hz</p> <p>EGA560.4X/680.4X/1000.4X</p>	<p>CH 5</p> <p>LPF</p>  <p>50Hz 150Hz</p> <p>EGA530.5X/1000.5X</p>
---	---	---

Variable Low-Pass Filter (50Hz-150Hz) : For use as a dedicated subwoofer channel, set filter switch to "LPF". Adjust variable crossover frequency with control as desired. The amplifier input circuit filters out everything above 50Hz150Hz (dependent on the adjustment of the frequency control), so only the deepest bass notes are amplified.

11. High Pass Filter Control

<p>HPF</p>  <p>50Hz 600Hz</p> <p>EGA300.2X/400.2X/500.2X EGA700.2X/1000.2X</p>	<p>CH 1/2</p> <p>HPF</p>  <p>50Hz 600Hz</p> <p>CH 3/4</p> <p>HPF</p>  <p>50Hz 600Hz</p> <p>EGA560.4X/680.4X/1000.4X/530.5X</p>	<p>CH 1/2</p> <p>HPF</p>  <p>50Hz 600Hz</p> <p>CH 3/4</p> <p>HPF</p>  <p>50Hz 600Hz</p> <p>CH 5</p> <p>HPF</p>  <p>50Hz 600Hz</p> <p>EGA1000.5X</p>
---	--	---

Variable High-Pass Filter (50Hz-600Hz) : For use as a dedicated mid high range channel, set filter switch to "HPF". The input circuit filters out all frequencies below 50Hz 600Hz.

Controls & Functions

12. Phase Shift Control

PHASE
SHIFT



0° 180°

EGA300.2X/400.2X/500.2X
EGA700.2X/1000.2X

CH 1/2

PHASE
SHIFT



0° 180°

CH 3/4

PHASE
SHIFT



0° 180°

CH 5

PHASE
SHIFT



0° 180°

EGA1000.5X

EGA560.4X/680.4X/1000.4X

PHASE SHIFT SWITCH (0 AND 180 DEGREES): Allows you to change the phase of your subwoofer from 0 and 180 degrees to help compensate for timing differences between drivers.

13. Remote Control Input - Fig 1.

REMOTE



EGA300.2X/400.2X/500.2X
EGA700.2X/1000.2X/560.4X
EGA680.4X/1000.4X
EGA530.5X/1000.5X

Remote Bass Boost Control : Optional EGA-RM

14. Input Select Switch



5CH 1-4CH MIX

EGA530.5X/1000.5X

Input Select Switch :

1-4CH : When signal is put into RCA input of CH1/2/3/4, 5CH Operates

5ch : When signal is put into RCA input of CH1/2/3/4/5, 5CH Operates

Controls & Functions

15. LED Indicator

POWER



PROTECT



EGA300.2X/400.2X/500.2X
EGA700.2X/1000.2X/560.4X
EGA680.4X/1000.4X
EGA530.5X/1000.5X

POWER : This GREEN LED will illuminate when the amplifier is turned "ON". If it fails to illuminate, check the power connections to the Amplifier and fuses.

PROTECT : The amplifier protection circuitry will disable the amplifier if input overload, short circuit or extremely high temperature conditions are detected. When the protection mode is in operation, the LED indicator on the side panel will be illuminated, indicating the amplifier has gone into a self-preservation mode.

If you observe that the Protection LED is lit, please check the system carefully to determine what has caused the protection circuit to engage. The amplifier can be reset by turning the remote power off and then on again. If the amplifier shut down due to a thermal overload condition, please allow it to cool down before restarting. If the amplifier shut down because of an input overload or short circuit, be sure to repair these conditions before attempting to power up the amplifier again.

Fig 1.

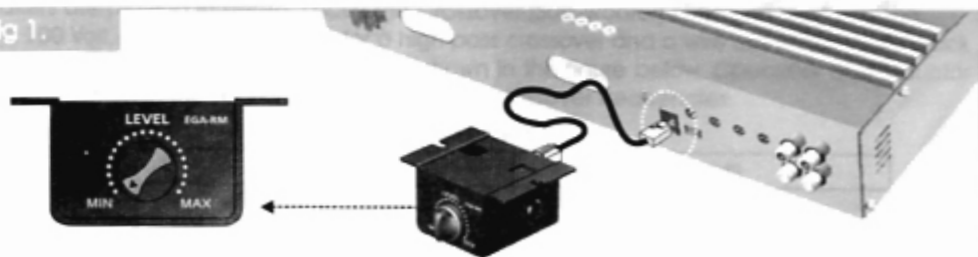

Remote Bass Boost Control : Optional EGA-RM

Remote Bass Boost Control : This control adjusts the Bass Boost gain for the amplifier's speaker output (0 - +12dB)

Planning and Mounting Your System

The mounting position of your Amplifier will have a great effect on its ability to dissipate the heat generated during normal operation.

Under normal conditions, the heatsink will dissipate sufficient heat to avoid thermal shutdown. However please do not install the amplifier in a wooden box or similar device as this will prevent heat dissipation into the atmosphere.

Temperatures in car trunks have been measured as high as (155°F) in the summer time. since the thermal shut-down point for the amplifier is (158°F) it is easy to see that it must be mounted for maximum cooling capability. To achieve maximum advantage of convection air flow in an enclosed trunk, mount the amplifier in a horizontal position.

Cooling requirements are considerably relaxed when mounting inside the passenger compartment since the driver will not often allow temperatures to reach a critical point. Floor mounting under the seat is usually satisfactory as long as there is at least 1 inch of clearance (2.54 cm) above the Amplifier's fins for ventilation.

- A. Select a suitable location that is convenient for mounting, is accessible for wiring. And has ample room for air circulation and cooling.
- B. Use the amplifier as a template to mark the mounting holes. Remove the Amplifier and drill holes. Use extreme caution, inspect underneath surface before drilling!
- C. Secure the Amplifier using the screws provided.

MONO MODE

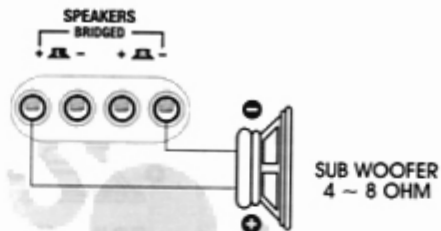

STEREO MODE

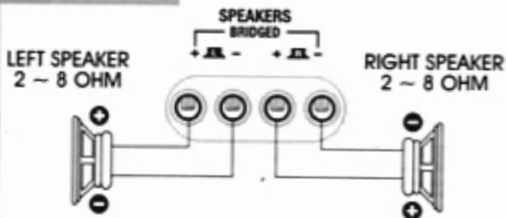

TRI MODE

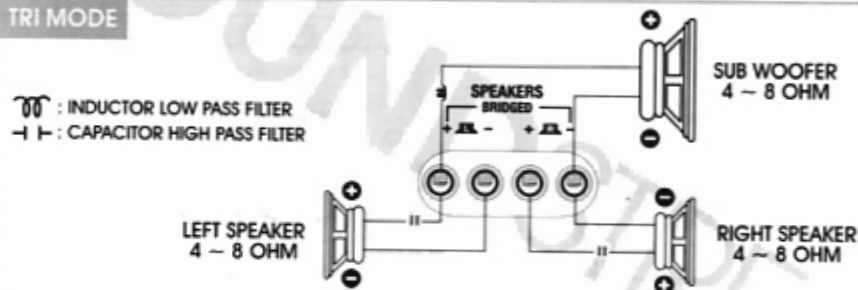

TRI MODE OPERATIONAL OUTPUT allows a Speaker to be operated in MONO mode while the main speakers are playing in stereo. Leave the Crossover (Sub-woofer) switch on "Full" position. Use a 100 Volt, non polar capacitor for a high pass crossover and a wire coil (inductor) to block high frequencies from the (Sub) Woofer as shown in the figure below. Capacitor and inductor values as written in the section below determine crossover frequencies.

SPEAKER IMPEDANCE

FREQUENCY	4 OHMS		8 OHMS	
	H	C	H	C
60 Hz	11.8 mH	600 uF	23 mH	300 uF
80 Hz	8.2 mH	500 uF	16 mH	250 uF
100 Hz	6.2 mH	400 uF	12 mH	200 uF
120 Hz	4.2 mH	300 uF	8 mH	150 uF

6 dB/Octive High Pass and Low Pass Filter

EGA560.4X/680.4X/1000.4X

2 CHANNEL MODE

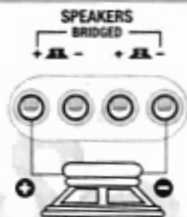

SUB WOOFER
4 - 8 OHM

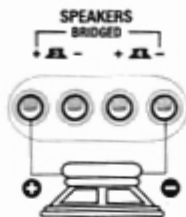

SUB WOOFER
4 - 8 OHM

3 CHANNEL MODE

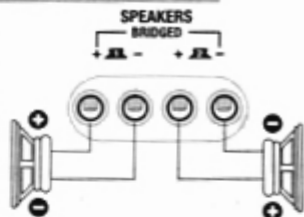

CH 3
2 - 8 OHM

CH 4
2 - 8 OHM

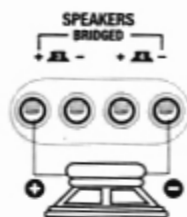

SUB WOOFER
4 - 8 OHM

4 CHANNEL MODE

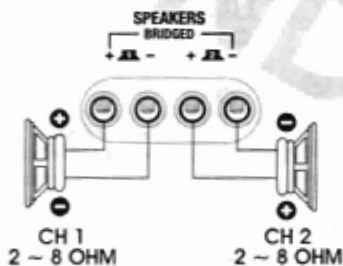

CH 1
2 - 8 OHM

CH 2
2 - 8 OHM

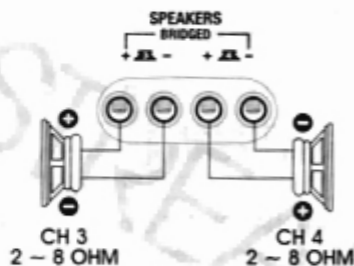

CH 3
2 - 8 OHM

CH 4
2 - 8 OHM

6 CHANNEL MODE

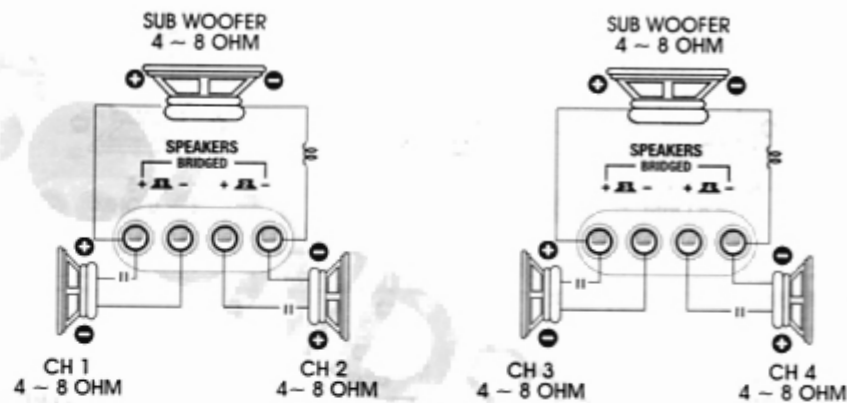

: INDUCTOR LOW PASS FILTER
 : CAPACITOR HIGH PASS FILTER

SPEAKER IMPEDANCE

FREQUENCY	4 OHMS		8 OHMS	
	H	C	H	C
60 Hz	11.8 mH	600 uF	23 mH	300 uF
80 Hz	8.2 mH	500 uF	16 mH	250 uF
100 Hz	6.2 mH	400 uF	12 mH	200 uF
120 Hz	4.2 mH	300 uF	8 mH	150 uF

6 dB/Octave High Pass and Low Pass Filter

EGA530.5X/1000.5X

3 CHANNEL MODE

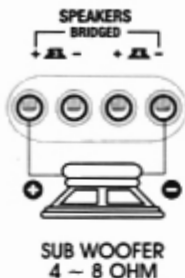
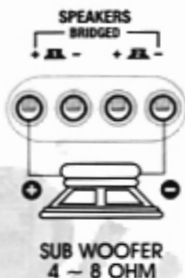

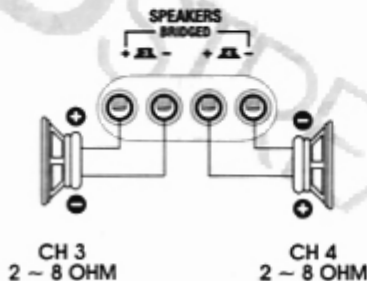
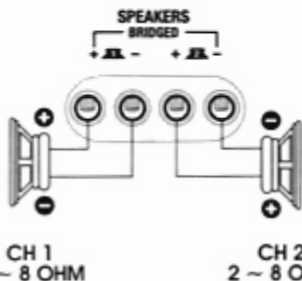

5 CHANNEL MODE

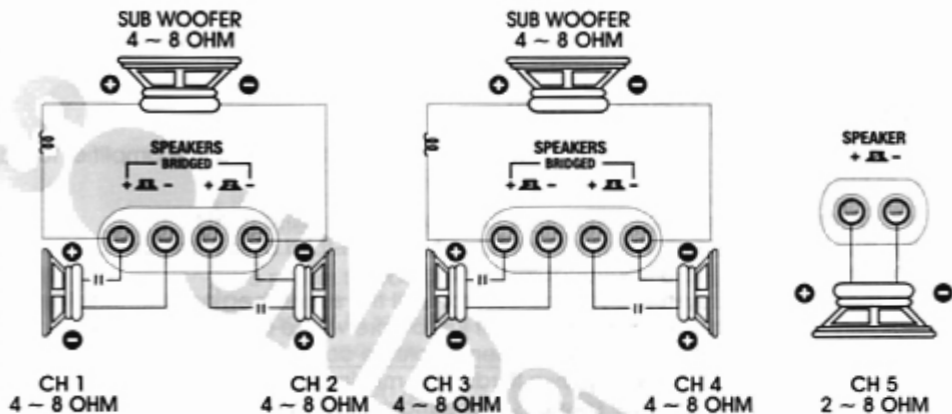

TRI MODE



 : INDUCTOR LOW PASS FILTER
 : CAPACITOR HIGH PASS FILTER

SPEAKER IMPEDANCE

FREQUENCY	4 OHMS		8 OHMS	
	H	C	H	C
60 Hz	11.8 mH	600 uF	23 mH	300 uF
80 Hz	8.2 mH	500 uF	16 mH	250 uF
100 Hz	6.2 mH	400 uF	12 mH	200 uF
120 Hz	4.2 mH	300 uF	8 mH	150 uF

6 dB/Octive High Pass and Low Pass Filter

Tuning on the Amplifier

The amplifier automatically turns on a few seconds after you turn your vehicle's ignition switch to ACC or ON or turn on your auto sound system, depending on how you wired the system. The POWER indicator on the top of the amplifier lights when the amplifier is on.

Important : Your amplifier requires 30 amps or more of power from your vehicle's battery during operation. To protect your battery from discharging, do not operate the amplifier unless your vehicle is running.

Adjusting The Audio Level

For the best performance, you must set GAIN (MIN / MAX) on the side of the amplifier to adjust the level of the audio signals that enter the amplifier.

1. Use a screwdriver to turn GAIN (MIN / MAX) fully counterclockwise to MIN.
2. Turn the auto sound system's volume control to about one-third of its full range.
3. Adjust GAIN (MIN / MAX) to a comfortable listening level.
4. Turn up the auto sound system's volume control until the sound begins to distort. Then immediately turn the volume down to a point just before where the distortion began.
Caution : Never turn up the auto sound system's volume control more than needed to adjust the audio level, more than two thirds of its maximum volume.
5. Adjust GAIN (MIN / MAX) until the sound is at the maximum level you want the amplifier to produce.
6. Adjust the auto sound system's volume control to a comfortable listening level.

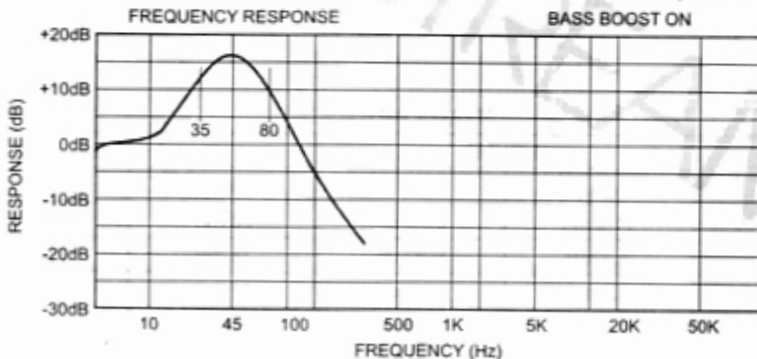

NOTE: Raising the Bass frequency allows higher frequencies to reach the bass speakers while blocking lower frequencies from midrange speakers. Lowering the Bass frequencies allows lower frequencies to reach the midrange speakers while blocking higher frequencies from bass speakers.

Trouble Shooting

SYMPTOMS	CHECK	REMEDY
NO SOUND	Is the power LED illuminated? (NO)	Check fuses in amplifier. Be sure Turn-on lead is connected check signal leads. Check gain control. Check Tuner / Deck volume level. Clean contacts on fuse holders.
	Is the Diagnostic LED illuminated? (YES)	Check for speaker short or amplifier overheating.
AMP NOT SWITCHING ON	No power to power wire	Repair power wire or connections.
	No power to remote wire with receiver on	Check connections to radio.
	Burnt or broken fuse	Replace fuse
NO SOUND IN ONE CHANNEL	Check Speaker Leads	Inspect for short circuit or an open connection.
	Check Audio Leads	Reverse Left and Right RCA inputs to determine if the problem is occurring before the amp.
AMP TURNING OFF MEDIUM / HIGH VOLUME	Check Speaker load impedance	Be sure proper speaker load impedance recommendations are observed. (If you use an ohmmeter to check speaker resistance, please remember that DC resistance and AC impedance may not be the same.)
PROTECTION LAMP ON	Shut down	Turn radio down Wait for AMP to cool
	Speaker wires shorted	Separate speaker wires and insulate



SOUNDSTREAM
www.soundstream.com