

GPS NAVIGATION
MOBILE VIDEO SYSTEM
4.3 INCH WIDE TFT LCD MONITOR

Instruction Manual **VIR 4100N**

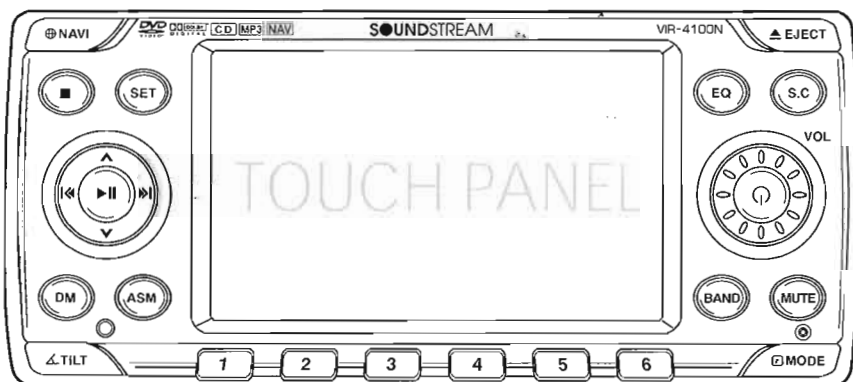

Take the time to read through this instruction manual.

Familiarity with installation and operation procedures will help you obtain the best performance from the unit.

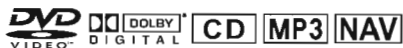

Contents

Introduction	2	My Favorite	46
Safety Precautions	3	▪ Favorites.....	46
Warning	4	▪ Recent destination.....	47
Box Contents	5	▪ Home.....	48
Name and function of each part	6	▪ Office.....	49
▪ Unit.....	6	▪ Advanced.....	49
Remote Controller	8	DVD Control	51
Mode Selection	9	DVD Setup	52
Quick Start Guide to Navigation	10	▪ Downmix Setup.....	53
Quick Access Menu	12	▪ TV Display Setup.....	53
Navigation On-Screen Descriptions	13	▪ OSD Lang Setup.....	54
Configure Menu	16	▪ Audio Setup.....	54
▪ Volume control.....	16	▪ Subtitle Setup.....	54
▪ Change language.....	17	▪ Screen Saver Setup.....	55
▪ Change Voice.....	18	▪ Defaults Setup.....	55
▪ Units of measurement.....	19	AV1 / AV2 Control	56
▪ Setup 2D/3D/North.....	20	Tuner Control	57
▪ Setup Speed/Time.....	21	ASM Function	58
▪ Setup Arrival/Remaining.....	22	Screen Setup	59
▪ Show POI.....	23	▪ Bright Setup.....	60
▪ Auto scale.....	24	▪ Contrast Setup.....	60
▪ Alert.....	25	▪ Color Setup.....	61
▪ GPS status.....	26	▪ Dimmer Setup.....	61
▪ Change map color.....	27	Audio Setup	62
▪ Change menu theme.....	28	▪ Bass Setup.....	63
▪ Time zone.....	29	▪ Middle Setup.....	63
▪ Day/Night.....	30	▪ Treble Setup.....	64
▪ Version.....	31	▪ Fader Setup.....	64
Navigate to – Menu	32	▪ Balance Setup.....	65
▪ Find by city.....	32	Installation & Connection	66
▪ Find by ZIP code.....	35	▪ How to install.....	67
▪ Home.....	36	▪ How to Remove.....	69
▪ Office.....	37	System Connection	70
▪ Recent route or Clear route.....	38	Glossary	72
▪ Find by favorites.....	39	Troubleshooting Guide	73
▪ Recent destination.....	40	Specifications	76
▪ Find by POI (Points of interest).....	41		
▪ Find by nearest POI.....	42		
▪ Find by map.....	43		
▪ Re route.....	44		
▪ Route Description.....	45		

Introduction

Thank you for choosing and purchasing this unit.

This instruction manual aims to provide you with installation and operating instructions for the unit.

Features

- High Resolution & Bright Active Wide TFT LCD with Touch screen.
- Picture Adjustable (Brightness, Contrast, Color)
- Fully Motorized Viewing Angle Adjustment
- Last Angle Memory

- Built-in GPS Antenna
- Easy & Quick GPS Program Upgrading with USB Socket
- Easy Starting up with SD Map Card

- DVD/VCD/CD/CD-R/CD-RW/MP3 Compatible
- DVD Last Position Memory
- NTSC/PAL Auto Selection
- Built-in FM/AM Tuner

- Full-Function Infrared Remote Control
- Max Output Power: 30W X 4ch
- 2 RCA AV Input (AV1, AV2)
- 1 RCA VIDEO Output
- 1 COAXIAL Output

NOTE This instruction manual is only for reference.
Modifying rights are reserved.
Modifications are subject to change without notice.

Safety Precautions



■ To prevent injury or fire, take the following precautions:

- To prevent a short circuit, never put or leave any metallic objects (such as coins or metal tools) inside the unit.
- Do not touch the liquid crystal fluid if the LCD is damaged or broken due to shock.
The liquid crystal fluid may be dangerous to your health or even fatal.
- If the liquid crystal fluid from the LCD contacts your body or clothing, wash it off with soap immediately.
- Do not watch Video or operate the unit while driving. It may cause a car accident because of the distraction.
To enjoy Video Pictures, find a safe place to park, and engage the parking brake.
- This unit is a Class 1 laser product. To prevent direct exposure to laser system, do not open the unit.
The laser beam may hurt your eyes.
- Note that TFT LCD is very fragile and could be easily damaged. Do not press or scratch the surface.
- Keep away the liquid from the main body to avoid possible electric shock or damage.
- Do not attempt to service this product by yourself.
(Don't repair this unit by yourself to avoid serious damage)
- In case of smoking or malfunction from the monitor, power off this unit immediately and contact dealer for service.
- It is the responsibility of the purchaser and installer to comply with all applicable laws and regulations governing the installation and use of this unit.
- Manufacturer disclaims all liability for any property damage or personal injury that may result from improper or unintended installation or use of this unit.

Safety Precautions



■ To prevent damage to the unit, take the following precautions.

- Make sure to ground the unit to a negative 12V power supply.
- Do not install the unit in a spot exposed to direct sunlight or excessive heat or humidity.
Also avoid places with too much dust or the possibility of water splashing.
- To prevent deterioration, do not touch the terminals of the unit or faceplate with your fingers.
- Do not subject the faceplate to excessive shock, as it is a piece of precision equipment.
- Don't watch Video pictures while the car's engine is off. (It may drain the battery)
- When replacing a fuse, only use a new fuse with prescribed rating. Using a fuse with the wrong rating may cause your unit to malfunction.
- Use only the screws provided. If you use the wrong screws, you could damage the unit.
- You cannot view video pictures while the vehicle is moving.
To enjoy TV/video pictures, find a safe place to park and engage the parking brake.

■ Loading and Replacing the remote battery

- 1 Use two "AAA" size batteries.
Slide the cover while pressing downwards to remove it as illustrated.
- 2 Insert the batteries with the + and - poles aligned properly, following the illustration inside the case.

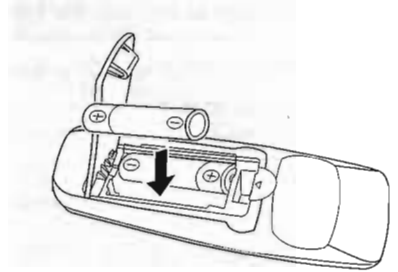

Warning



- Do not set the remote control on hot places such as above the dashboard.

■ Cleaning the panel and monitor

- When the operator panel and monitor panels are dirty, wipe and clean them using a soft cloth (such as a commercially available silicon coated cloth).
- When contaminated excessively, clean them using a cloth dipped in a neutral detergent first, then remove the detergent using a dry cloth.
- Do not use a hard cloth or a volatile chemical (such as an alcohol).

■ Cleaning the disc slot

- As dust can accumulate in the disc slot, clean it occasionally.
Your discs can get scratches if you put them in a dusty disc slot.

■ Lens Fogging

- Right after you turn on the car heater in cold weather, dew or condensation may form on the lens in the disc player of the unit causing lens fogging, discs may be impossible to play. In such a situation, remove the disc and wait for the condensation to evaporate.
- If the unit still does not operate normally after a while, consult your dealer.

Caution

If it is activative with over limited output, it will down the volume output for the safety set. Volume function will be stop temporarily untill the set become stabile status.
(After the set is stabile, Volume function will be keep in stabile status.)

BOX Contents

Name and Function of Each Parts

After purchasing this product, open packaging and see if any of the components listed below are damaged or missing. If there is an abnormality, please inquire to the dealer you purchased from. As these images are to facilitate the understanding of the consumer, they may differ from the actual conditions.



Unit 1 EA



Remote Control (1EA) & Batteries (2 EA)



Half Sleeve 1 EA(For Mounting Bracket)



Panel Base 1 EA (Trim Ring)



Power & Speaker Cable (16P) 1 EA



1 AV Cable (6P) 1 EA



2 AV Cable (8P) 1 EA



GPS Antenna 1 EA



Key 2 EA (For Removing a unit)



Map SD Card (2GB) 1 EA

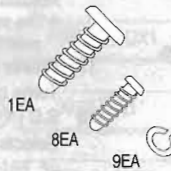

Screw (For Rear Mounting Bracket)/
Center Screw



Manual 1 EA



Warranty Card 1 EA



Filter Box

■ Front Panel Description

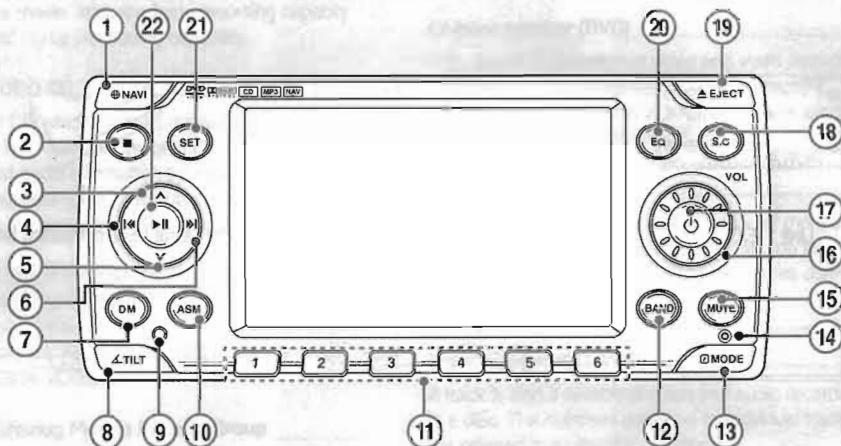

- 1 (⊕NAVI) button
Navigation mode.
- 2 Stop (●) button
Stops a disc.
- 3 UP (▲) button
Fast forward. The speed change in DVD mode.
Scans a frequency in radio mode.
- 4 FR (◀) button
Track changes in DVD mode.
Decreases frequency in radio mode.
- 5 DOWN (▼) button
Fast reversed. The speed change in DVD mode.
- 6 FF (▶) button
Track changes in DVD mode.
Increases frequency in radio mode.
- 7 DM (DM) button
DVD menu. PBE on/off when you play a VCD.
- 8 Tilt (▲TILT) button
Selects one of the following view angle.
→ 30° → 60° → 90° → 60° → 30° → 0°
- 9 Remote Control Eye
- 10 ASM (ASM) button
Auto frequency scan in radio mode.
- 11 Preset (1~6) button
Calls a preset frequency.
Memorizes current frequency.
- 12 BAND (BAND) button
Selects AM, FM1 or FM2.
- 13 MODE (⊙MODE) button
Selects one of the following mode.
→ DVD → NAVI → RADIO → AV1 → AV2 → SETUP
- 14 Hard Reset
- 15 MUTE (MUTE) button
Turns on or off the sound.
* Navi. Auto change on/off button when you press this more than 2 seconds(long key).
- 16 Volume button
Adjusts the volume.
* The max. volume level is 15 when you turn the unit on even if you set more than 15.
- 17 Power (⏻) button
Turns on or off the power.
- 18 S.C (S.C) button
Selects sound condition control menu.
→ BASS → MID → TREBLE → BALANCE → FADER
* Change the setting of the BASS, MID or TREBLE when EQ is off.
- 19 Eject (▲EJECT) button
The disc is ejected.
If no disc, the display will be open or previous tilt.
- 20 EQ (EQ) button
Selects equalizing menu.
→ CLASSIC → POP → ROCK → EQ OFF
- 21 SET (SET) button
Setup mode for DVD, SCREEN or AUDIO pressing the button again returns to the previous mode.
- 22 Play/Pause (▶||) button
Pauses and replays a disc.

Name and Function of Each Parts

Remote Controller

■ Left Side View

■ Front Side View

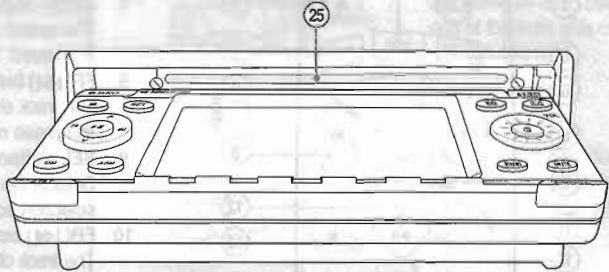
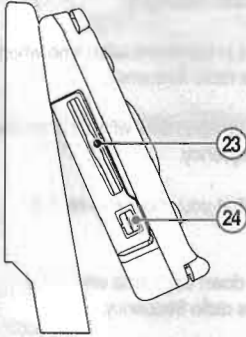

- 23 SD CARD SLOT
- 24 USB PORT
- 25 Disc insertion slot

■ Rear Side View

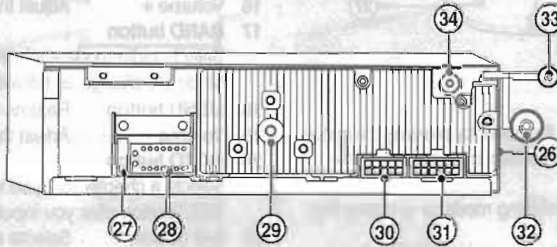

- 26 FAN
- 27 FUSE (20A)
- 28 Power & Speaker Output Connector
- 29 Center Hole
- 30 External Output Terminal (5.1ch Preout)
- 31 External Input Video Out Terminal
- 32 Tuner Antenna
- 33 IR Repeat
- 34 GPS Antenna

■ Front Side View



- 1 **Power button**
You can turn on or off the power by pressing the button.
- 2 **Eject (▲) button** The disc is ejected.
- 3 **Mode button**
Selects one of the following mode by pressing the button.
DVD → NAVI → RADIO → AV1 → AV2 → SETUP.
- 4 **DISP button**
Selects the one of the following time display mode in AUDIO CD. SINGLE ELAPSED, TOTAL ELAPSED, TOTAL REMAIN, OFF
Selects the one of the following time display mode in DVD. TITLE REMAIN, CHAPTER ELAPSED, CHAPTER REMAIN, DISPLAY OFF.
- 5 **TILT button**
Selects one of the following view angle by pressing the button. 30° → 60° → 90° → 60° → 30° → 0° degrees.

- 6 **SEEK+ button**
The speed changes in forward each time when it is pressed. Scans a radio frequency.
- 7 **SEEK- button**
The speed changes in backward each time when it is pressed. Scans a radio frequency.
- 8 **FF (▶▶) button**
The track changes up each time when it is pressed. Increases radio frequency.
- 9 **SEL button**
Selects the mode that you choose in MODE selection screen.
- 10 **FR (◀◀) button**
The track changes down each time when it is pressed. Decreases radio frequency.
- 11 **SETUP button**
Setup mode is selected for DVD, SCREEN or AUDIO. Pressing the button again returns to the previous mode.
- 12 **Play/Pause (▶||) button**
Pauses and replays a disc.
- 13 **Stop (■) button** Stops a disc.
- 14 **ASM button**
Auto frequency scan in radio mode.
- 15 **MUTE button**
You can turn on or off the sound by pressing the button. except Auto Search Frequency, Seek + button or Seek - button.
- 16 **Volume +** Adjust the volume up.
- 17 **BAND button**
Selects radio mode each time press the button. Mode will change as follows: AM → FM1 → FM2
- 18 **MENU button** Returns to the root menu.
- 19 **Volume -** Adjust the volume down.
- 20 **GOTO button**
Selects a chapter that you want to go. Press the "SEL" button after you input a chapter number.
- 21 **A-B button** Selects a repeat interval or OFF.
- 22 **LANG button** Selects a LANGUAGE.
- 23 **SUB-T button** Selects a SUB-TITLE or OFF.
- 24 **ANGLE button** Selects a view angle in DVD mode.
- 25 **ZOOM button**
Enlarges a screen each time you press it in DVD mode as follows: X1.5 → X2 → X3 → ZOOM OFF
- 26 **REPEAT button**
Repeats a TITLE or CHAPTER.
Menu will changes as follows: CHAPTER REPEAT ON → TITLE REPEAT ON → REPEAT OFF
- 27 **TITLE button**
Returns to the DVD root menu.

Mode Selection

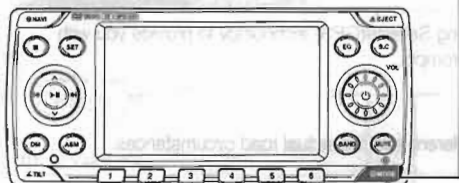

- When you press the power button, the last mode will be selected automatically. So if you'd like to change mode, then press the mode button or press the center of the screen.

If you are in NAVI mode, you should press the mode button, not touch screen.



The mode changes each time when the mode button is pressed.



The mode will be selected to the last one automatically after you leave it more than 5 seconds, and also it changes screen to the selected mode.

Introduction

This function is the navigator and very latest Global Positioning Satellite(GPS) technology to provide you with accurate street level navigation via clear and precise voice prompts.

- 01 Calculated routes and voice guidance are may be different from the actual road circumstances.
- 02 GPS positioning may not be available depending upon the vehicle's circumstance.
For instance, when you are inside a tunnel or a building.
- 03 Do not install the wireless device around this unit. It may cause a bad GPS signal reception.
- 04 If you are driving with bad signal reception, GPS positioning time may take longer than when you are stationary.
- 05 Keep your unit away from excessive moisture and extreme temperature.
- 06 Because of the GPS signal error(about 10 meters), or bad signal reception, Your position displayed on the map may be different from actual your position.
- 07 It may take some time to receive GPS signals(about 5 ~ 30 minutes) after initial purchase or in first time use after long period time unused.
Go to where the sky is visible, with no obstruction from skyscrapers and wait for good reception.
- 08 GPS signal reception can be effect by following situations, this is not a device problem.
 - * When you put a something on the GPS antenna.
 - * When you have metallic coating on the car glasses.
 - * When it is cloudy or bad weather
 - * When vehicle is inside a tunnel, under the elevated road, in an underground parking lot, in subway
 - * When vehicle is in skyscrapers

A Safety Precautions

- Look at the display only when it is absolutely safe to do so.
- Never attempt to disassemble, repair or make any modification to your device since this could cause damage to the device, and even bodily injury or property damage.
- Keep SD cards in a well-protected case so as to avoid dust and humidity when you are not using it and also make sure that no foreign objects can enter the SD slot.

Quick Start Guide to Navigation

Quick Access Menu

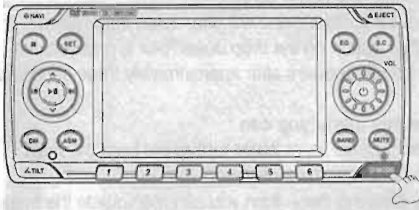

- 1 Press the mode button or center of the screen. The following screen will be display with last mode is already selected.

The mode changes each time when the mode button is pressed.



- 2 Leave it about for 5 seconds when NAVI is selected or press the  icon directly. then the NAVI mode will be start for a moment.

- 3 If there is no SD card, following screen will be on, then Insert the SD card into the SD Card slot as indicated.

- 4 Following screen will be display once after the power on, otherwise the last NAVI screen will be on.

- 5 Read information and press **I agree** button at the bottom of the screen.

- 6 Go out after you have installed the device, so that the GPS receiver can locate your position. This may take up to 30 minutes the first time the device is used. When satellite lock is achieved the screen displays your position on its map in a '3D' navigation view.

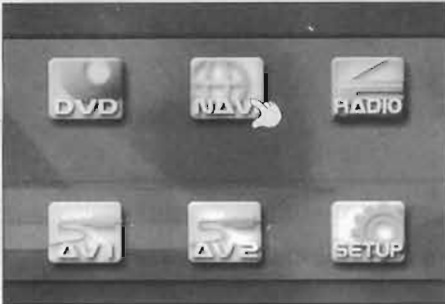

TIP To reduce the 'cold start' GPS time remain stationary Your position(and direction) is indicated by the  icon.

NOTE It may cause a NAVI. problem to insert or eliminate SD CARD while you turn the unit on.

NOTE The Navigation map version has been changed.

Information

Please do not operate the controls of goNgo while driving. Doing so could endanger yourself, your passengers and other road users.

Please observe the actual traffic signal.

I agree

Quick Access Menu

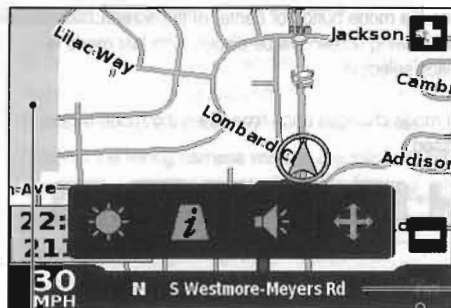

Press the left side of the map to see the navigate avoiding road.

Press this icon to see the 'GPS Status'







A small on-screen menu can be launched by pressing the bottom line of the screen.

The quick access menu will drop down automatically. If no other button on the drop down "box is pressed, the drop box disappears after approximately three seconds."

From this menu you can :

- Zoom closer in, or zoom further out from the map.
- Mute or alter the audil level.
- By pressing the + icon you can manipulate the map.
- Switch between day and night settings

Press the bottom of the screen get Following quick menu

	<p>Day / Night in Configure menu Press the icon to switch the setting - If you switch the unit off and then back on the display, it reverts to previous personal setting.</p>
	<p>Road information You can get the road information</p>
	<p>Volume setting Press the + button to increase, – button to decrease the volume. Press the  icon for mute. you will see  - This new setting is only temporary and if the unit is switched off and then back on the audio level returns to either factory default or your personal setting.</p>
	<p>Scroll map By pressing this icon you can manipulate the map by touching and moving your finger on the screen.</p>
<p>Add favorites</p>	<p>Press the Quick menu after you scroll the map.</p>
<p>Target</p>	<p>Press the Add favorites or Target to set the current position</p>
	<p>GPS status</p>





1	Turning direction at the intersection	7	Current street
2	Distance to intersection	8	GPS antenna status
3	Estimated time of arrival or estimated journey time. Press to switch between the two.	9	My position
4	Remain distance	10	Current road
5	Vehicle speed or current time. Press to switch between the two.	11	Road information of the turning point
6	Current direction		

Navigation Mode Menus

Navigation On-Screen Descriptions



1 Bring up the main navigation menu by pressing the center of the screen.
There are three Main Menus.

2 Press the  button to see the 12 sub-menus of the  menu.

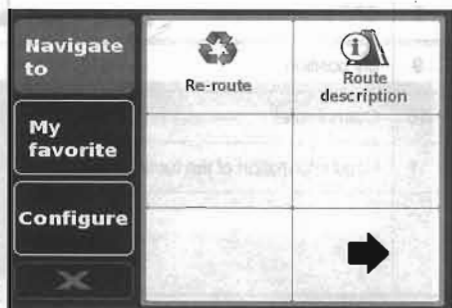

My Favorite Mode Menu



1 Press **My favorite** button to see the 4 sub-menus.

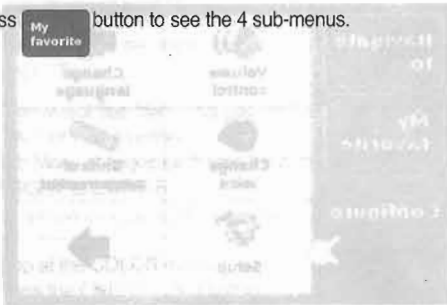

Configure Mode Menu

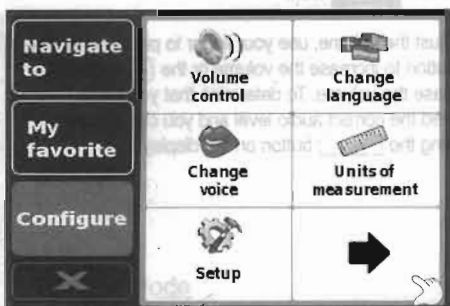

2 Press the **Configure** button to see the sub-menus.
Press the **→** button to see the all 12 sub-menus.

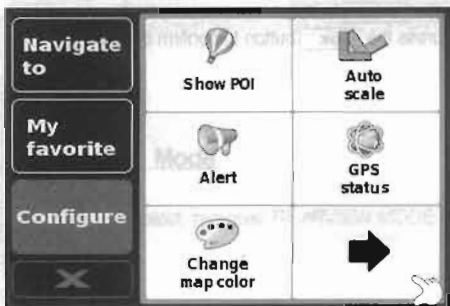
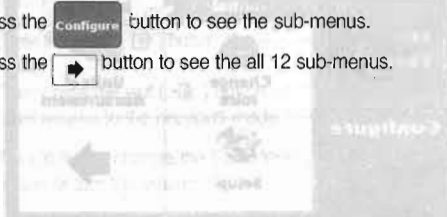

3 Press **→** button to return to the previous screen.

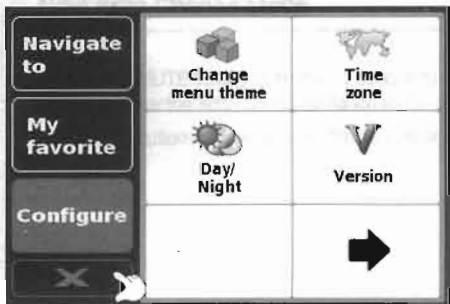

Configure Menu

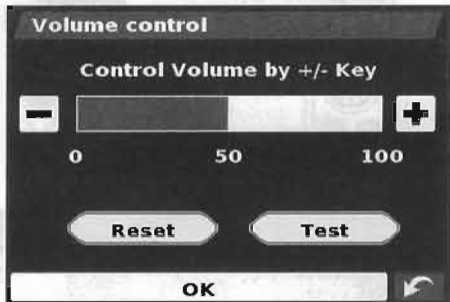
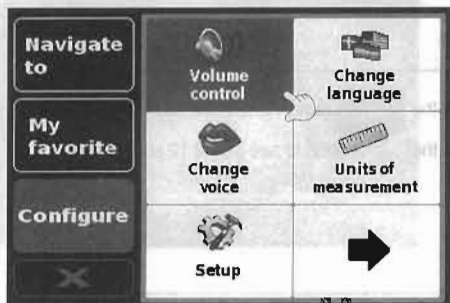
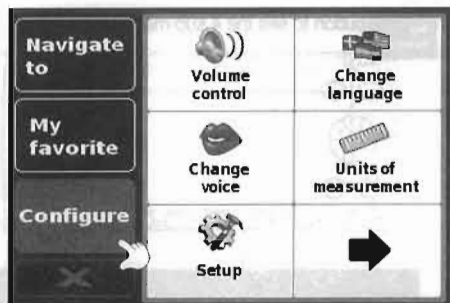

Volume Control Menu

- 1 Bring up the main navigation menu by pressing the center of the screen.
- 2 Press the **Configure** button.
- 3 Press the **Volume control** icon.
- 4 To adjust the volume, use your finger to press either the **+** button to increase the volume or the **-** button to decrease the volume. To determine that you have selected the correct audio level and you can test by pressing the **Test** button on the display.
- 5 If you wish to return to the factory default audio level press the **Reset** button. Then press the **OK** button to confirm the setting.

Configure Menu

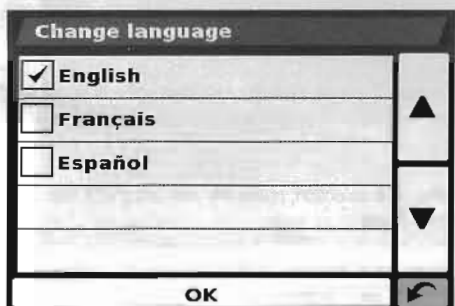
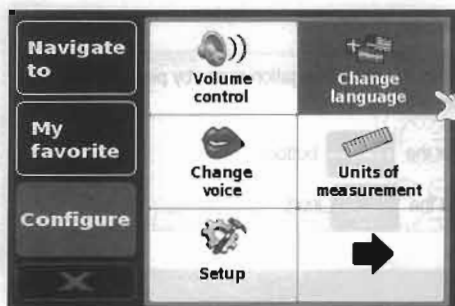

Change language

- 1 Bring up the main navigation menu by pressing the center of the screen.
- 2 Select the **Configure** button.
- 3 Press the **Change language** icon.
- 4 Your device comes with a choice of a ENGLISH , Espanol or French voice prompts and alerts.
- 5 When you have decided which language you prefer, press the 'OK' button.

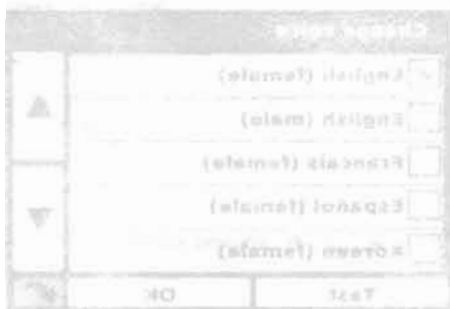

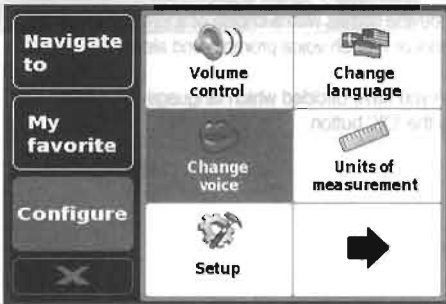
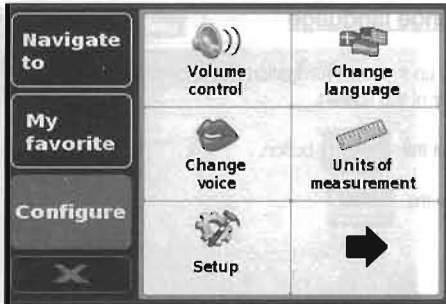

Change Voice

1 Bring up the main navigation menu by pressing the center of the screen.

2 Select the **Configure** button.

3 Press the **Change voice** icon.

4 Your device comes with a choice of a male, female, southern or Urban English voice prompts and alerts.

Also female Espanol, French or Korean voice is possible. To hear a sample of each voice, press the (test) button once.

5 To make your selection, press the relevant check box with your finger.

6 When you have decided which language you prefer, press the **OK** button.

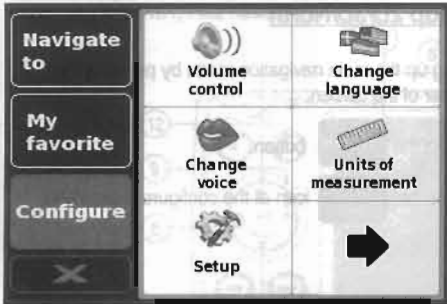

Units of measurement

- 1 Bring up the main navigation menu by pressing the center of the screen.
- 2 Select the **Configure** button.
- 3 Press the **Units of measurement** icon.

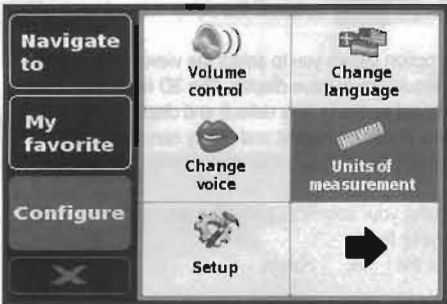

- 4 This option allows you to display between metric and imperial measurement.
- 5 To make your selection, press the relevant check box with your finger.
- 6 When you have decided which language you prefer, press the **OK** button.

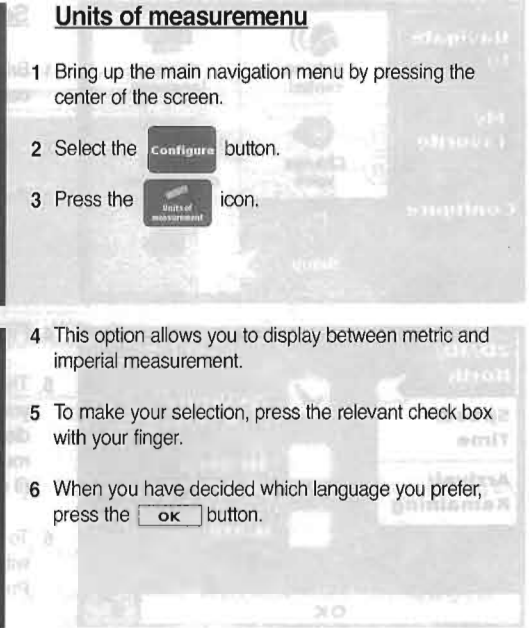
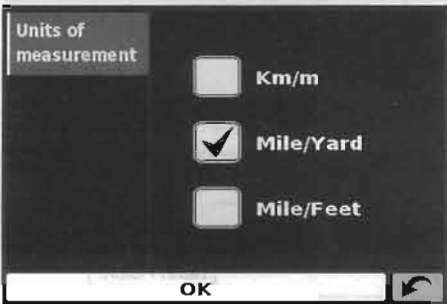

Configure Menu

Navigation

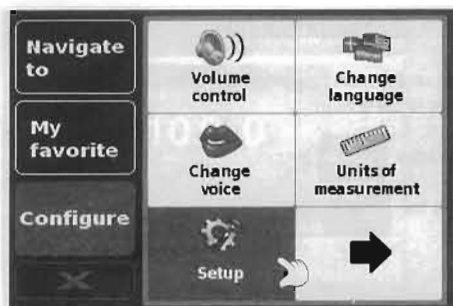

Setup 2D/3D/North

- 1 Bring up the main navigation menu by pressing the center of the screen.
- 2 Select the **Configure** button.
- 3 Press the **Setup** icon at the configure main menu.
- 4 Press the **2D/3D/North** button at the setup sub menu.
- 5 This option allows you to select the view of the map that you would like to have display. The 3D navigation view is displayed as the factory default and displays the map, routes, points of Interest and safety camera data (if subscribed to) from a 3D perspective.
- 6 To make your selection, press the relevant check box with your finger. Press the **OK** button.

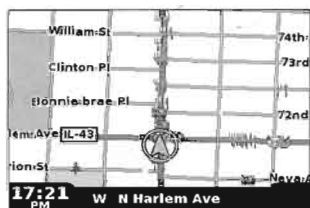
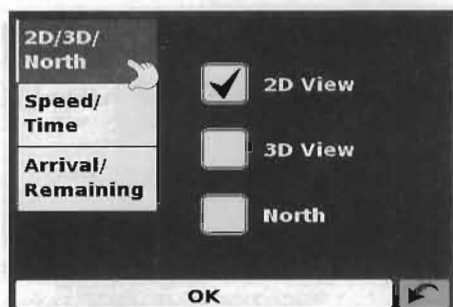

[2D Picture]



[3D Picture]



[North Picture]

Configure Menu

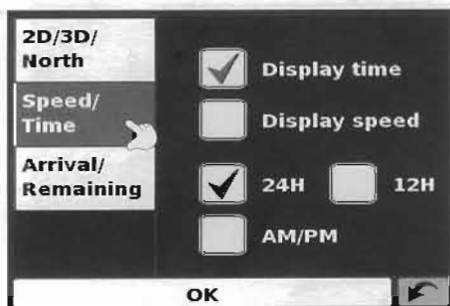
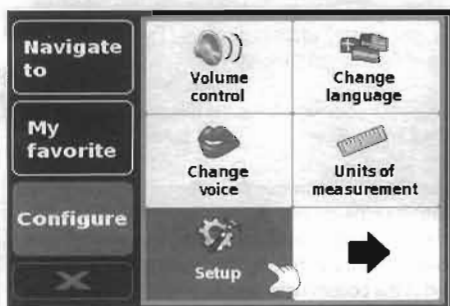
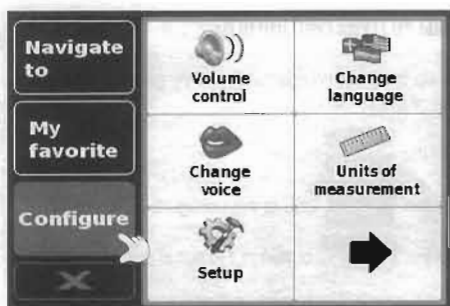

Setup Speed/Time

- 1 Bring up the main navigation menu by pressing the center of the screen.
- 2 Select the **Configure** button.
- 3 Press the **Setup** icon at the configure main menu.
- 4 Press the **Speed/Time** button at the setup sub menu.

This option allows you to change the information displayed in the bottom left hand side of the navigation screen between the vehicle speed and the current time.

- 5 To make your selection, press the relevant check box with your finger.
Press the **OK** button.

Configure Menu

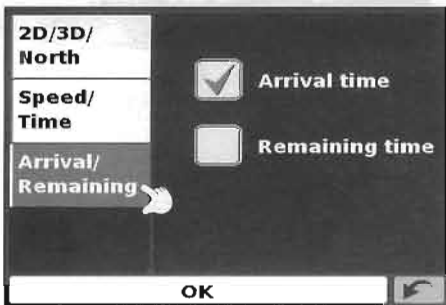
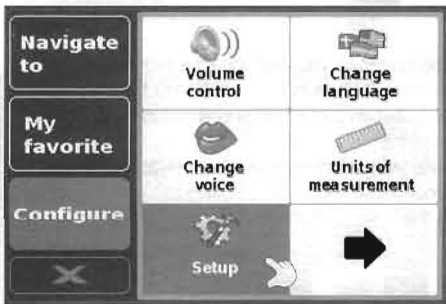
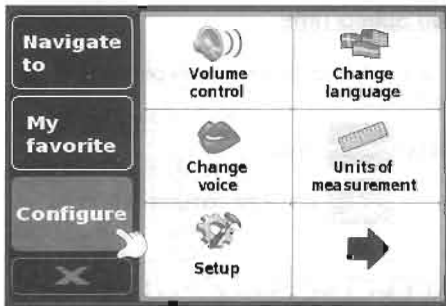

Setup Arrival/Remaining

- 1 Bring up the main navigation menu by pressing the center of the screen.
- 2 Select the **Configure** button.
- 3 Press the **Setup** icon at the configure main menu.
- 4 Press the **Arrival/Remaining** button at the setup sub menu.
- 5 This option allows you to display either the estimated time of arrival(ETA) or the estimated remaining time left for your journey which is displayed towards the bottom of the navigation screen.
- 6 To make your selection, press the relevant check box with your finger. Press the **OK** button.
- 7 To save any of the changes press the **OK** button at the bottom of the display.
If you wish to keep the settings unchanged you can exit the 'Setup' menu by pressing the return arrow  located in the bottom right hand corner of the display. Your new settings will now be saved and will appear on the screen each time you use your unit.

Configure Menu

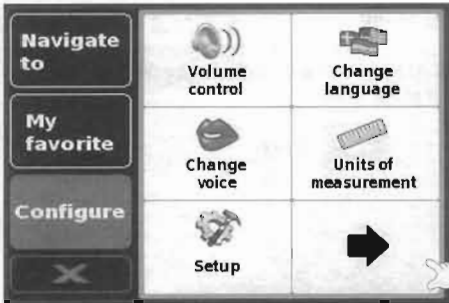

Show POI

1 Bring up the main navigation menu by pressing the center of the screen.

2 Select the **Configure** button.

3 Press the **Show POI** button.

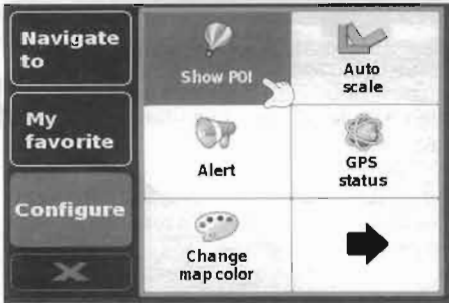

4 This device comes completed with a comprehensive list of POI's Point's of Interest.

You can choose which of these POI's you would like to have indicated on your map.

As standard ALL POI's are shown, however this list can be edited within the POI's menu.



5 The screen will now show a list of POI's stored on your unit with a 'check' box to the left of each type of POI.

Simply press the checked box to select or deselect the POI. A red check in the box indicates that the POI will appear on your map, any un-check box will remove the POI from the map view. To scroll through the list of POI's you can press either the up or down arrows located on the right hand side of the display.

To remove ALL POI's from the map un-check the ALL check box at the top of the list of POI's.

To save the changes press the **OK** button at the bottom of the display. If you wish to exit the 'Show POI' list without saving any changes press the return arrow located in the bottom right hand corner of the display.

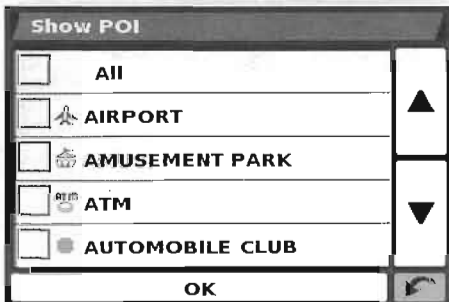

6 Then press the **OK** button to confirm the selection.

Configure Menu

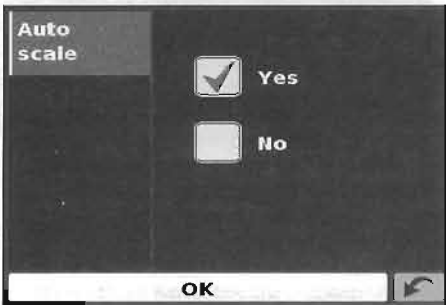
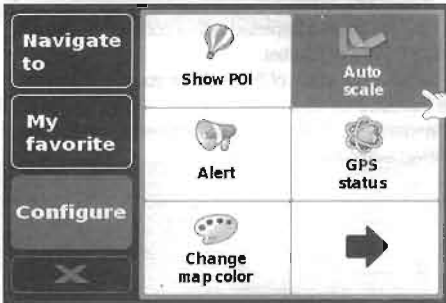
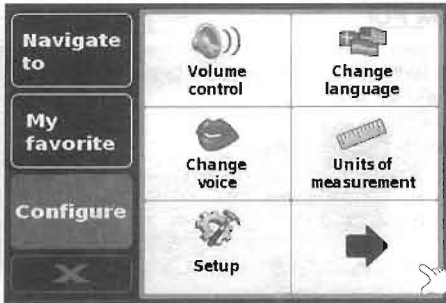

Auto scale

- 1 Bring up the main navigation menu by pressing the center of the screen.
- 2 Select the **Configure** button.
- 3 Press the **Auto scale** button.
- 4 Auto scale is programmed by default to 'On' manufacture. Auto scale automatically magnifies the map as you approach a junction or roundabout, where you may need to make a turning.

Auto scale can be turned on and off as you wish. Make your selection by pressing the check box next to the option you would like to choose.
- 5 To save the setting press the **OK** button at the bottom of the display. If you wish to keep the setting unchanged you can exit the 'Auto Scale' configuration menu by pressing the return arrow  located in the bottom right hand corner of the display.

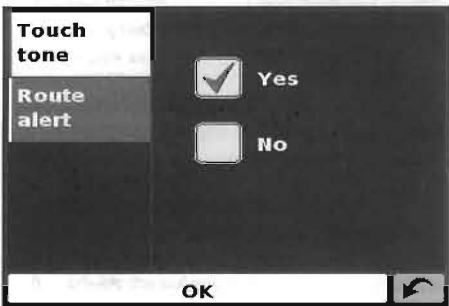
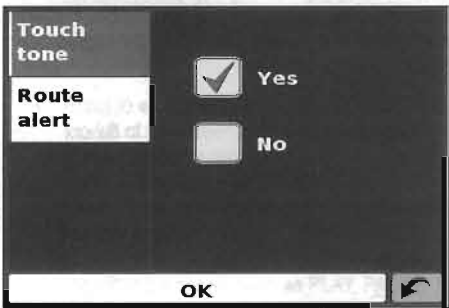
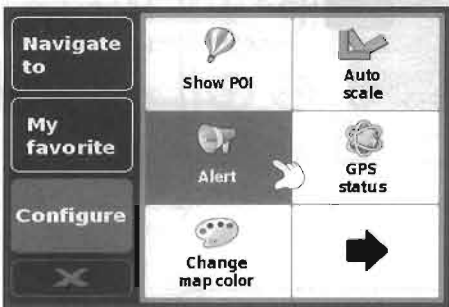
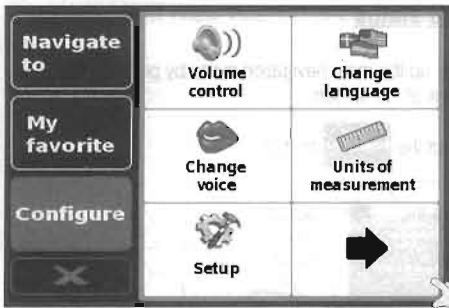

Alert

- 1 Bring up the main navigation menu by pressing the center of the screen.
- 2 Select the **Configure** button.
- 3 Press the **→** button.
- 4 Press the **Alert** button.
- 5 This function allows you to alter the audible alerts provided during navigation and to turn the audible beeps on or off while selecting functions on the display. By default both these options are switched **OK**. To change any of the settings press the relevant box and a check mark will appear in the box to confirm your selection.
- 6 You can choose between the following options:
 - Yes:** The unit emits a confirmation tone each time the screen is touched.
 - No:** This will turn off the confirmation beep when the screen is touched.
- 7 If you deviate from the planned route the unit will automatically recalculate a route without any user intervention. To indicate Re-Routing is in progress the unit will emit a tone.
 - You can choose between the following options:
 - Yes:** The Re-Route tone will be emitted during recalculation.
 - No:** No Re-Route tone will be emitted.

Configure Menu

Configure Menu

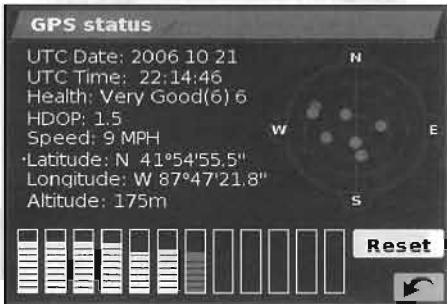
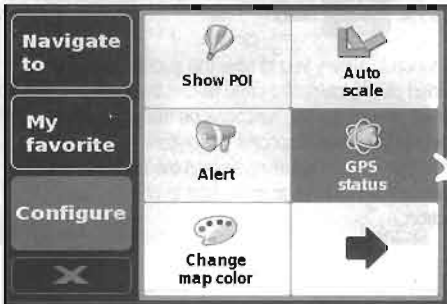
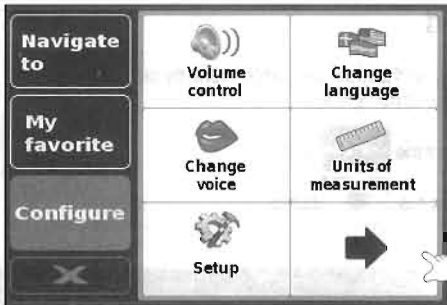

GPS status

- 1 Bring up the main navigation menu by pressing the center of the screen.
- 2 Select the **Configure** button.
- 3 Press the **➔** button.
- 4 Press the **GPS status** button.
- 5 You can check the status of your GPS connection at any time as well as being able to Locate of your current position by using this feature.

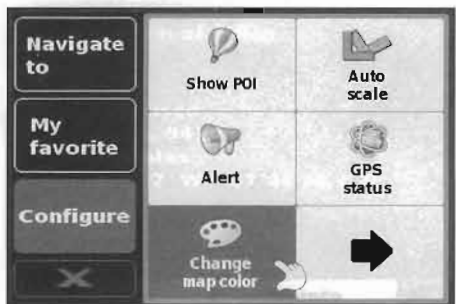
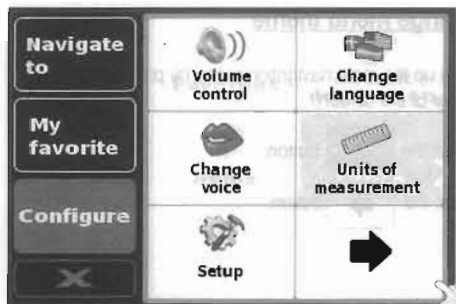

Change map color

This option allows you to choose between the alternative color schemes that are available for the maps used in your system (several of which are most suitable for use at night).

- 1 Bring up the main navigation menu by pressing the center of the screen.
- 2 Select the **Configure** button.
- 3 Press the **Change map color** button.
- 4 Press the **Change map color** button.
- 5 Press the **←** and **→** to cycle through the different day color schemes.
- 6 There are eleven color schemes to choose from. To save your selection press the **ok** button at the bottom of the display.

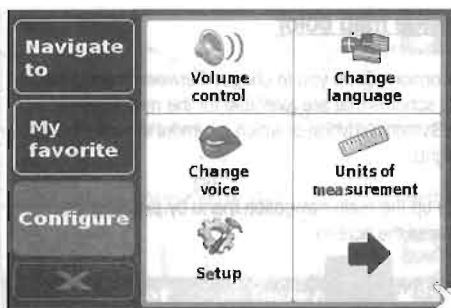

Change menu theme

- 1 Bring up the main navigation menu by pressing the center of the screen.
- 2 Select the **Configure** button.
- 3 Press the  button.

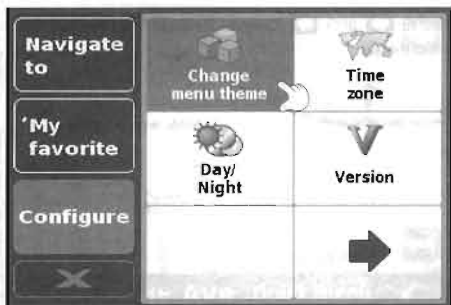
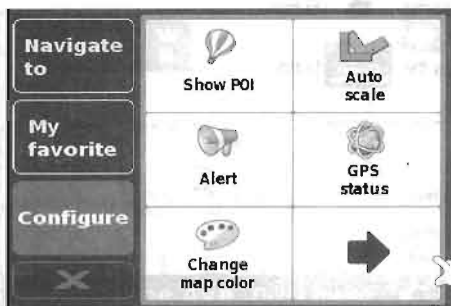
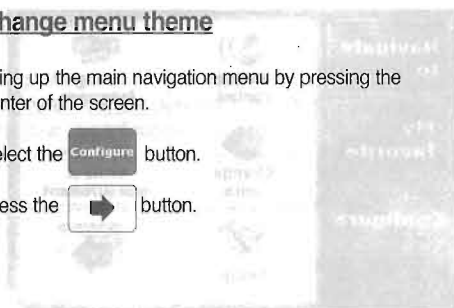

- 4 Press the **Change menu theme** button.



- 5 You can change the menu color as you wish. Make your selection by pressing the check box next to the option you would like to choose.
- 6 To save the setting press the **OK** button at the bottom of the display. If you wish to keep the setting unchanged you can exit the menu by pressing the return arrow  located in the bottom right hand corner of the display.

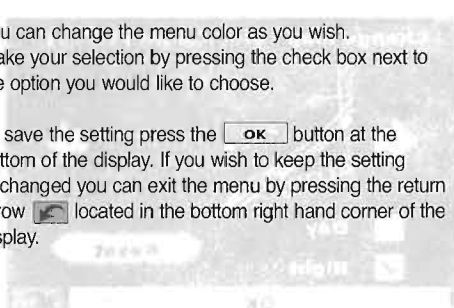

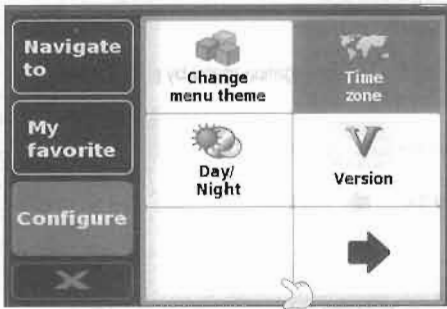

Time zone

- 1 Bring up the main navigation menu by pressing the center of the screen.
- 2 Select the **Configure** button.
- 3 Press the **→** button.
- 4 Press the **Time zone** button.
- 5 You can select the time display by marking the auto or manual. Select the auto and press the **OK** button.

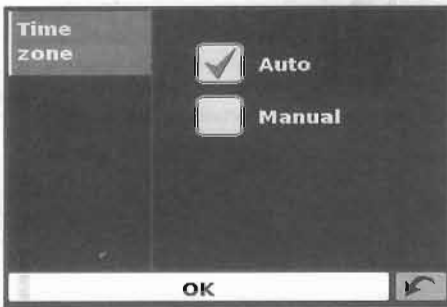

- 6 If you select the manual, you will see the **Use DST** and **Change** button.
- 7 Press the **Change** button.



- 8 Press the right or left arrow icon to select proper time zone.
- 9 To save the setting press the **OK** button at the bottom of the display. Press the check box next to the 'use DST' if you like to choose DST time.







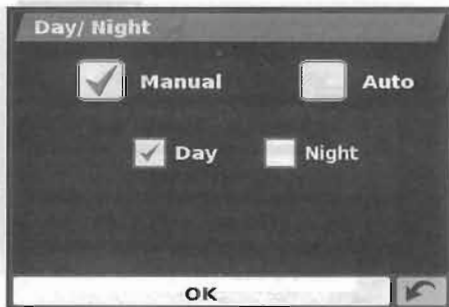
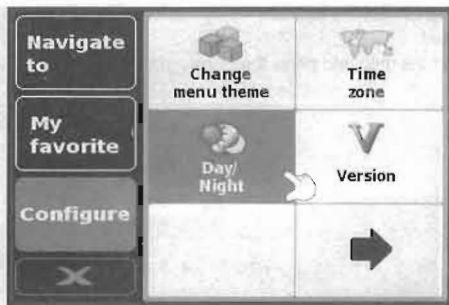
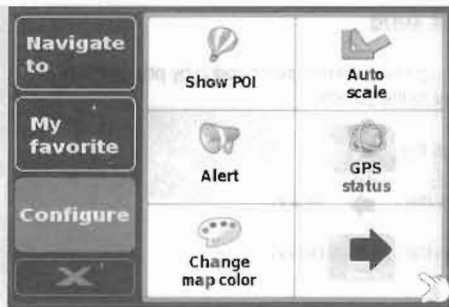

- 10 If you wish to keep the setting unchanged you can exit the menu by pressing the return arrow  located in the bottom right hand corner of the display.

Configure Menu



Day/Night

- 1 Bring up the main navigation menu by pressing the center of the screen.
- 2 Select the  button.
- 2 Press the  button.
- 3 Press the  button.
- 4 Press the  button.
- 5 Select and check box for manual and day or night.
- 6 Press the  button to save the selection.
- 7 Select the check box for **Auto**.
To Adjust the day start time, press the right or left arrow icon. To adjust the night start time, press the right or left arrow icon.
- 8 Press the  button to save the selection.

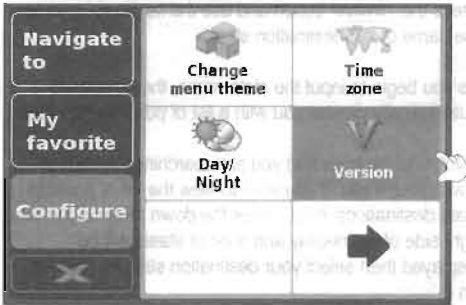
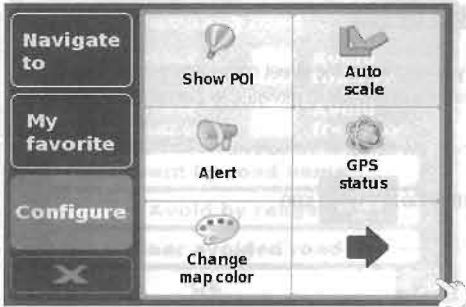

Version

- 1 Bring up the main navigation menu by pressing the center of the screen.
- 2 Select the **Configure** button.
- 3 Press the **→** button.
- 4 Press the **→** button.
- 5 Press the **Version** button.
- 6 You can find out the H/W, S/W and map version.
- 7 If you wish to check the reliability of the software data on your SD card, then press this button and the unit will perform a 'system check' to ensure that the SD card information is at optimum efficiency.
- 8 If you wish to exit the menu, press the return arrow  located in the bottom right hand corner of the display.

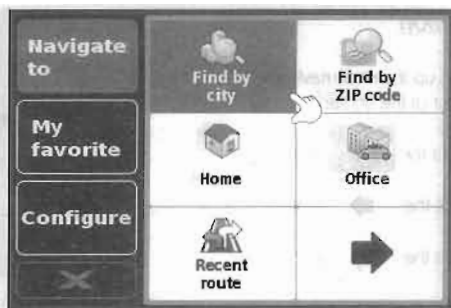

Find by city

If you only know the street name and the town or city that you would like to navigate to then select this option.

- 1 Press the center of the screen.
- 2 Press the  icon.

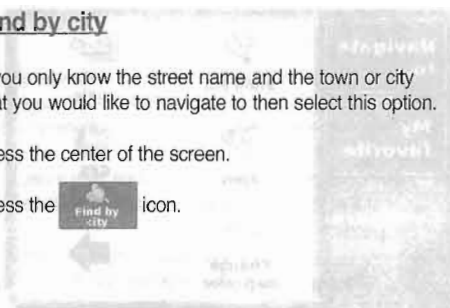

- 3 Press the **State** button and use the keyboard to enter the name of the destination state.

As you begin to input the state name, the device will automatically prompt you with a list of possible matches.

If you find the state that you are searching for, then press it with your finger. If you wish to view the list of possible state destinations in full, press the down arrow to the top right side of the display and a list of states will be displayed then select your destination state by pressing on it.

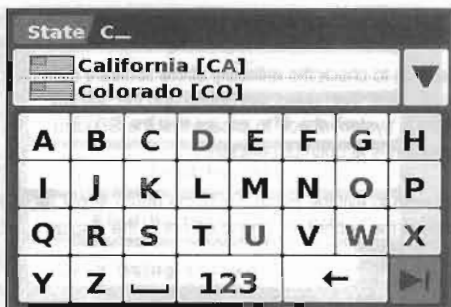
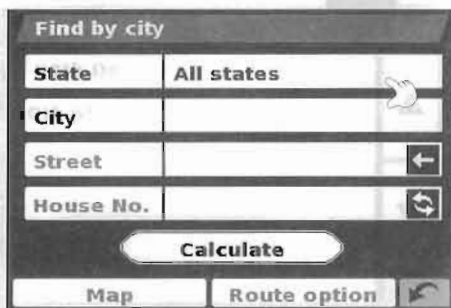

Navigate to – Menu

City S_

Sacramento (CA)
Salida (CA) ▼

A	B	C	D	E	F	G	H
I	J	K	L	M	N	O	P
Q	R	S	T	U	V	W	X
Y	Z	_	123	←	→		

St. J_

Jonathan Dr
Kendall Ct ▼

A	B	C	D	E	F	G	H
I	J	K	L	M	N	O	P
Q	R	S	T	U	V	W	X
Y	Z	_	123	←	→		

H.N. [1 ~ 599]_

1	2	3	←
4	5	6	-
7	8	9	ABC
_	0	OK	→

Find by city

State	California [CA]
City	San Francisco (CA)
Street	10th St ←
House No.	9 ↻

Calculate

Map Route option ↻

- 4 If you select the state then the device will automatically prompt you with a next option in order. City, Street, House No., intersection.
- 5 For even more accurate routing you can enter the property number by pressing 'House No.' and then typing the house number on the keyboard. Once the house number has been selected, press the **OK** button.

Intersection

Alternatively, if you do not have a house or building number, your device can navigate you to a point where two roads meet instead. After you have entered the name of the road you would like to navigate to, press the 'intersection' button.

All list of all roads that connect or intersect the road you would like to navigate to will be shown. Simply select the road with your finger and then select 'Calculate' and your device will create a route to the intersection of those two roads.

- 6 Once you have entered your information you can now press the 'Calculate' button and the device will calculate a route ready for you to navigate to. Once the calculation is completed, press **GO** to start the navigation.

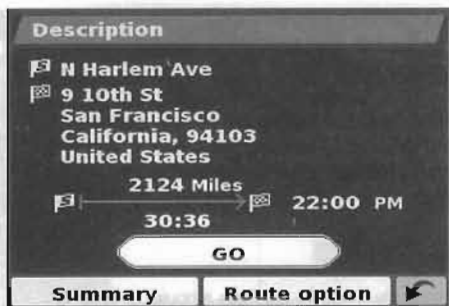

7 **Route option** to change the parameters of the route or 'Guide' which will list the turn by turn instructions of the journey.

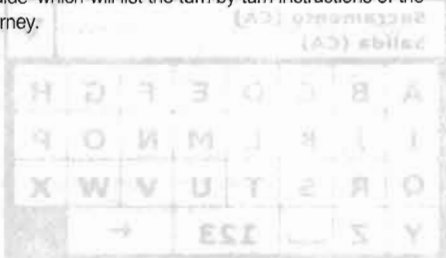

8 The 'Summary Screen' will tell you the distance to your destination, estimated time of arrival and the estimated time it will take to completed your journey.

- The default rout options are set to 'Shortest time'.

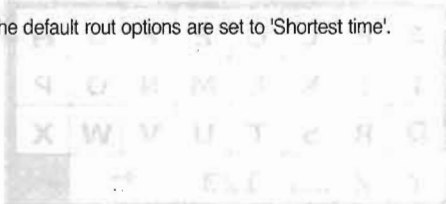

- : Start Position
- : Final Destination
- : Estimated journey time
- : To continue navigation
- Simulation** : To see actual route
- Guide** : Detailed route turn by turn.



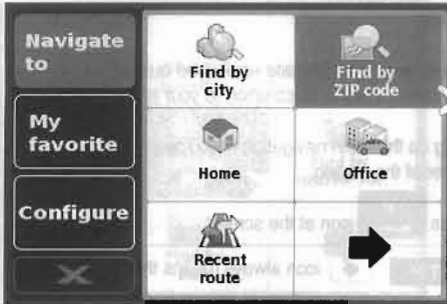

Find by ZIP code

- 1 Bring up the main navigation menu by pressing the center of the screen.
- 2 Press (Find by ZIP code)icon at the screen.

TIP

➡ icon always means that there are more options to see on the next screen.



- 3 You'll see a standard browser screen, used for entering ZIP codes.
- 4 Enter your country and ZIP code using the keyboard and press **OK** button.

TIP

- Use the blank key to separate the two segments of the postal code.
- For more accurate navigation you can enter a Street or House number by pressing the 'Street' or 'House No' button.
- You can change the parameters to click the check box.

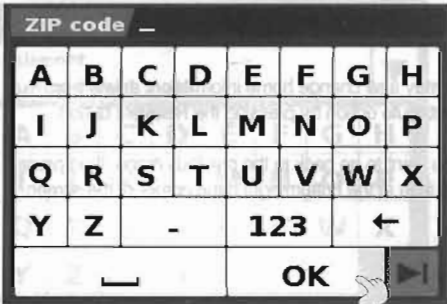

- 5 Click (Calculate) and the device will calculate the fastest route from your current position to your destination. This should take only a few seconds to progress.
- 6 A journey summary screen will be displayed for approximately 10 seconds before the unit automatically begins to provide you with turn by turn instructions.

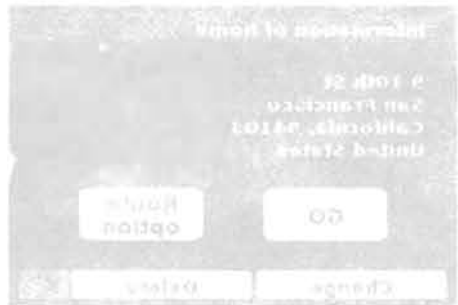
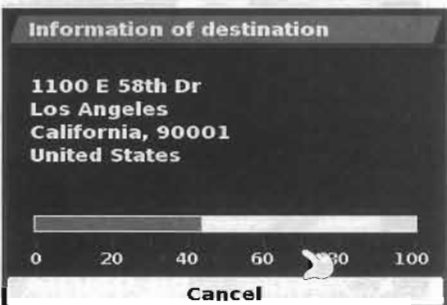

Navigate to – Menu

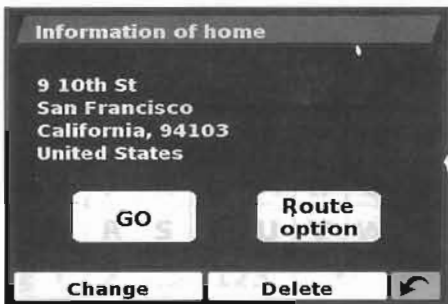
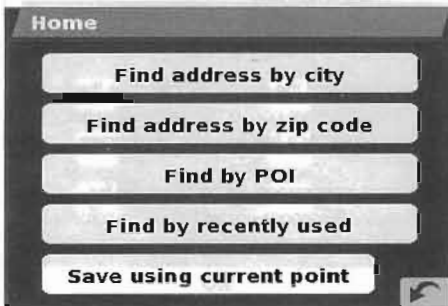
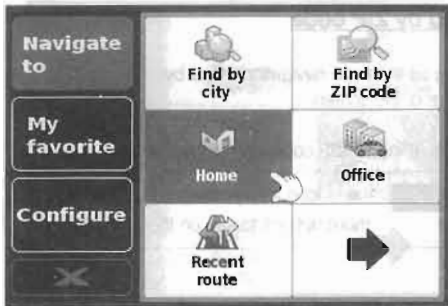

Home

To enable you to navigate easily and quickly from a previous journey or destination to your home,

- 1 Bring up the main navigation menu by pressing the center of the screen.

- 2 Press  icon at the screen.

TIP

 icon always means that there are more options to see on the next screen.

- 3 The first time 'Home' function is used the unit will ask if you want to set your home location, press OK in the information window, If 'Home' has already been set it can be edited in My Favorites.

- 4 Press  button and a route will automatically be created.

- 5 You may also change home information, delete it or select route option by pressing the Relevent button.

- 6 If you want to go back to the previous menu, then press  icon at the bottom-right hand corner of the screen.

Navigate to – Menu

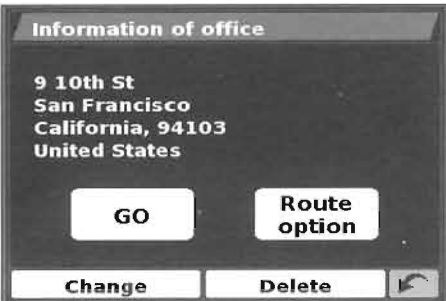
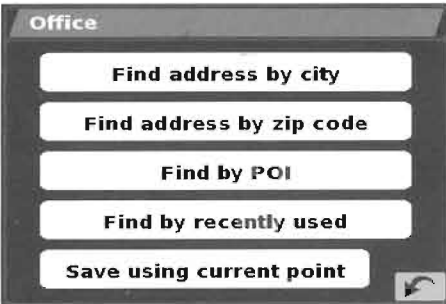
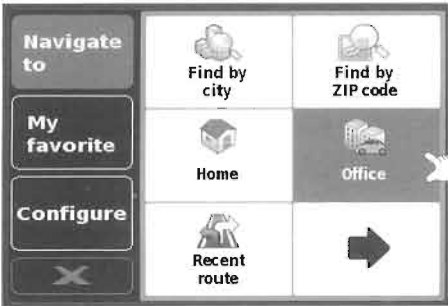

Office

To enable you to navigate easily and quickly from a previous journey or destination to your Office or place of work you can personalize your unit so that a route can be calculated by pressing just a few buttons.

1 Bring up the main navigation menu by pressing the center of the screen.

2 Press  icon at the screen.

TIP  icon always means that there are more options to see on the next screen.

3 When the first time 'Office' function is used the unit will ask if you want to set your office location, press OK in the information window, If 'Office' has already been set it can be edited in My Favorites. (Refer to page 46.)

4 Press  button and a route will automatically be calculated.

5 You can change or delete the office information by pressing the relevant button.

6 If you want to go back to the previous menu, then press  icon at the bottom-right hand corner of the screen.

Navigate to – Menu

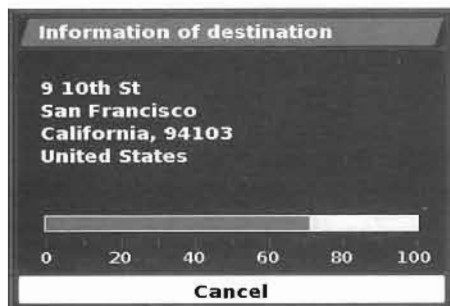
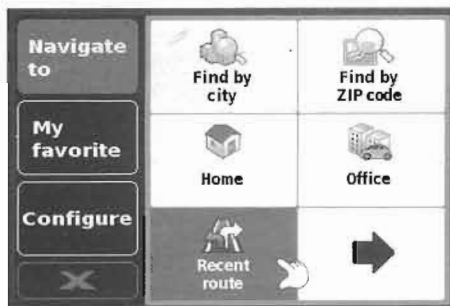
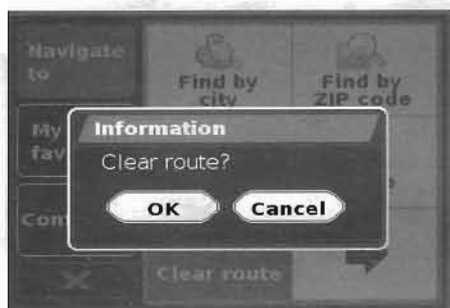
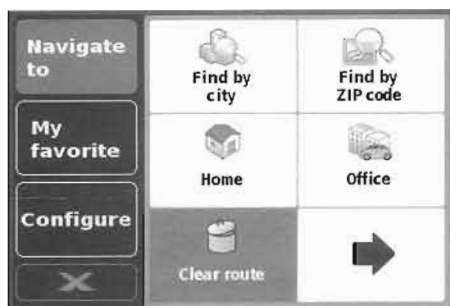

Recent route or Clear route



- 1 The unit automatically stores the last route that has been calculated. So that if you wish to return to that address you do not have to re-input all the details again.
- 2 To calculate a route using the 'Recent route' function , press the center of the screen to enter the 'Navigate To' menu. Select the 'Recent route' icon. The unit will now calculate the route to your selected location.
- 3 Once a route has been calculated the 'Recent route' icon is replaced with a 'Clear route' icon.
To cancel a route that you have calculated, access the Menu by pressing the center of the screen, Press the 'Clear route' icon. The route will then automatically be deleted.

For the 'Clear route' feature to operate you will need to have entered and calculated a route.
If the 'Recent route' icon is displayed a route has NOT been entered.

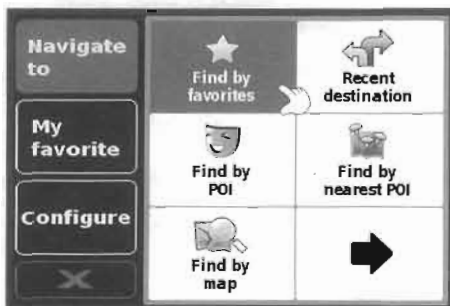
Navigate to – Menu



Find by favorites

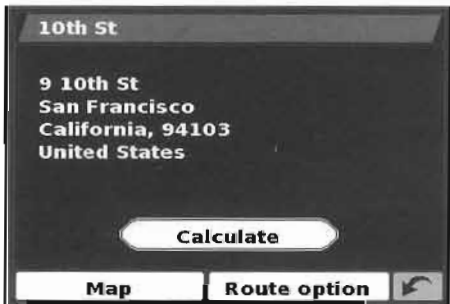
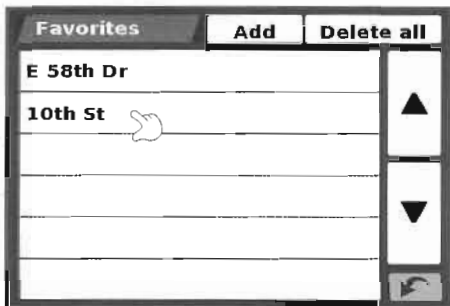

- 1 This unit has enough capacity to store many users location.
- 2 To navigate to one of your stored locations, press the center of the screen to enter the 'Navigate To' menu. Press the Arrow  and then select the 'Find by Favorite' icon.
- 3 Select the favorite you wish to navigate from the list provided. The information about your chosen favorite is displayed.
- 4 To view the location of the favorite, press 'Map'. To return to the previous page press the return arrow  located on the bottom right hand corner of the display.
- 5 To change the route parameters, press 'Route Options'. To return to the information page press 'Done'.
- 6 Press 'Calculate' and the unit will calculate the route to your selected favorite. Once the calculation is completed the summary screen is displayed. You can either press 'Go' to start navigation, 'Simulation' to see the actual route, 'Route Options' to change the parameters of the route or 'Guide' which will list the turn by turn instructions.

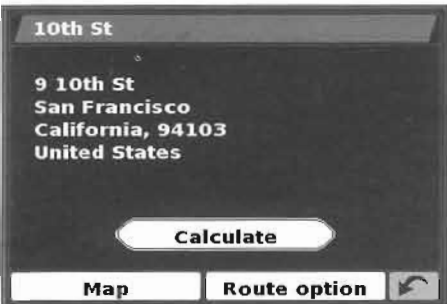
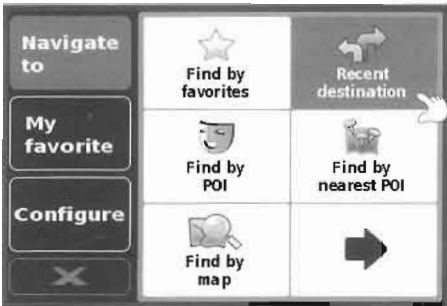

Navigate to – Menu



Recent destination

- 1 This unit is capable of storing the last 40 routes that have been calculated, do that if you wish to return to an address you do not have to re-input the details again.
- 2 To calculate a route using the 'Recent destination' function, press the center of the screen to enter the 'Navigate To' menu. Press the Arrow  and then select the 'Recent destination' icon. to your selected location.
- 3 A list of your most recent routes will be shown in chronological order, use the down arrow on the right hand side of the display to scroll through the list and select the destination you would like the unit to navigate to.
- 4 An 'Information of Destination' screen will appear confirming the address you have selected.
- 5 If you would like to view a map of the recent destination, press 'Map'. To return to the 'Information Of Destination' page press the return arrow  located in the bottom right hand corner of the display.
- 6 If you would like to change any of the route parameters press 'Route Option' (see Route Option on page 41 for specific instructions). To return to the 'Information Of Destination' page press 'Done'.
- 7 Press **Calculate** and the unit will now calculate the route to your selected recent destination. Once the calculation is completed the summary screen will display.
- 8 You can either press 'Go' to start navigation, 'Simulation' to see the actual route, 'Route Option' to change the parameters of the route or 'Guide' which will list the turn by turn instructions.

Navigate to – Menu

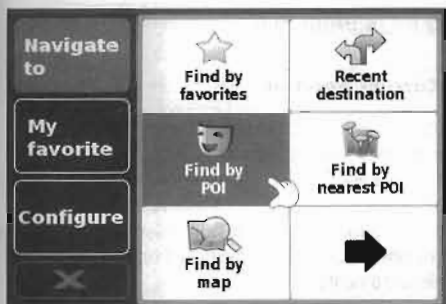

Find by POI (Points of interest)

- 1 If you would like to calculate a route to a hotel, airport, restaurant or even a golf course the unit can calculate a route using its extensive database of POI's (50 categories).
- 2 To navigate using this database press the center of the screen to access the menu. Press the  arrow and then select the 'Find by POI' icon as shown.
- 3 Select State, City, Category and Name then press 'Calculate' button. (Refer to 'Find by City' on page 29)

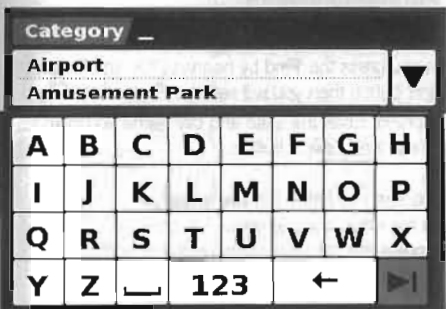
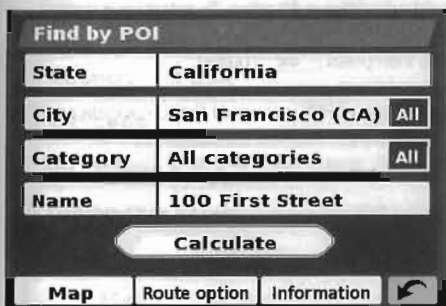

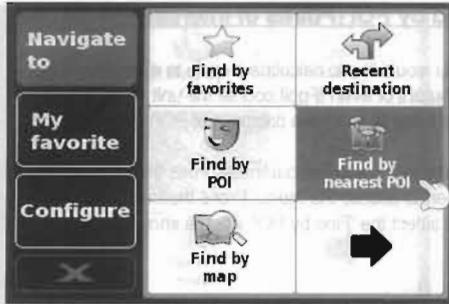

Find by nearest POI

Current position

- 1 This option will help you to find the nearest POI by Category within a specified radius. When you press the 'Find by nearest POI' and 'Current Position' button, the radius can be configured from a minimum radius of 10 miles up to a maximum radius of 60miles from your current location and can be increased or decreased by 10 mile increments.
- 2 The default setting is 30 miles. To select your desired radius press the check box next to the distance you require then press **OK** button.
- 3 Enter the type of POI you would like to navigate and as you begin to input the POI, the device will automatically prompt you with a list of possible POI's.
- 4 Select the POI you are searching for and press the **Calculate** button.

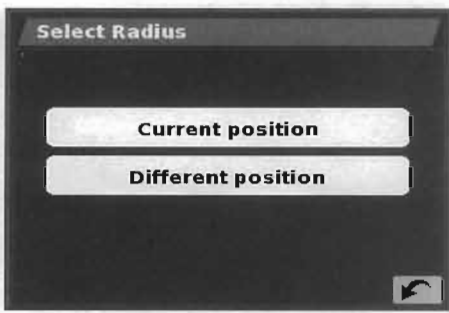

Different position



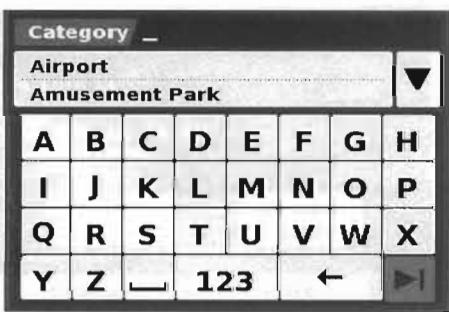
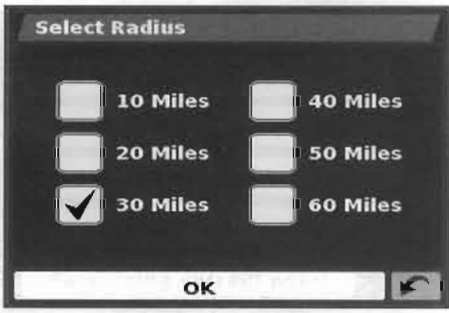

- 1 This option will find the nearest POI by City. When you press the 'Find by nearest POI' and 'Different Position' button then you will see the Find address by City' screen. Enter the state and city name you wish to, and press the **Set** button.
- 2 You will see the 'Select Radius' screen. Select the miles and category. Then press the calculate button at the bottom of the screen.

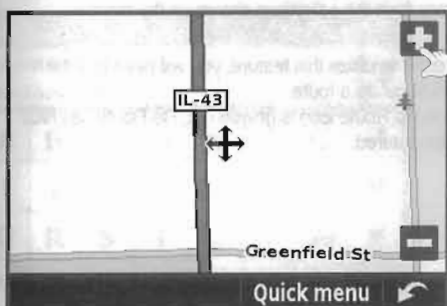
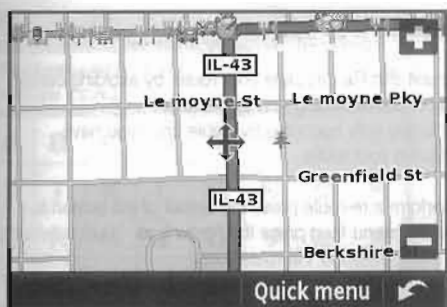

Navigate to – Menu



Find by map

- 1 This function allows you to select a destination by simply pressing any area of the map stored within your unit. You can create a route to a location by viewing the map and selecting a road or area with your finger. To navigate using this facility press the center of the unit screen to access the menu, press the arrow  and then select the 'Find by Map' icon as shown.
- 2 The screen will show a section of the map.
- 3 To see a larger section of the map press the  button to zoom out. If you would like to see the map in more detail, use the  button to zoom in.
- 4 By pressing and moving your finger on the screen you can move the map around until you find your desired location. When you can see the required target, simply press on the area of the map you would like to navigate to and the road selected will be displayed to the bottom left hand corner of the screen.
- 5 If you are happy with your selection press the (quick Menu) button and then (continue) and an Information of Destination: screen will be displayed.
- 6 If you like to view the map again, press 'Map'. To return to the 'Information of Destination' page, press the return arrow .
- 7 If you like to change any of the route parameters press 'Route option'. To return to the 'Information of Destination' page, press 'Done'.
- 8 Press 'Calculate' and the unit will now calculate the route to your selected destination. Once the calculation is completed the summary screen is displayed. You can either press 'Go' to start navigation, 'Simulation' to see the actual route, 'Route Options' to change the parameters of the route or Guide which will list the turn by turn instructions.
- 9 This screen will also tell you the distance to your destination, estimated time of arrival and the estimated time it will take to completed your journey.



Re route

- 1 This unit can Re-calculate your route by avoiding certain roads or redirecting you by distance. This facility only becomes available once you have calculated your route.
- 2 To perform a re-route press the center of the screen to enter the menu then press the Arrow  button twice and then select the 'Re-route' icon.
- 3 You can then choose how you would like to re-route your journey from the selections shown on the display.

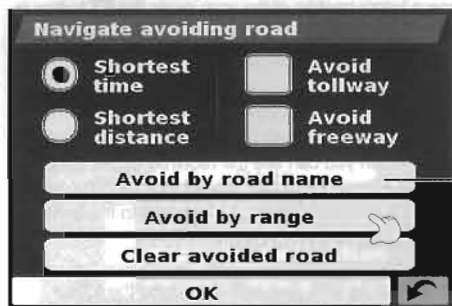

In order to utilize this feature, you will need to enter and calculate a route.
If the Re Route icon is grayed out, Re-Route has NOT been entered.

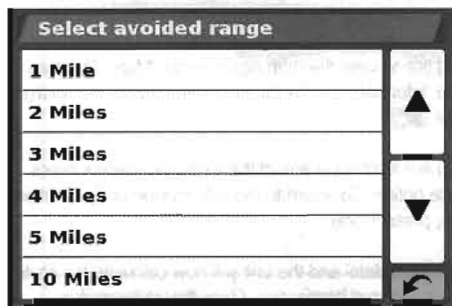

Avoid by road name

If you know the road name or number you wish to avoid then you can use this option.
Press 'Avoid by road name' and you will be provided with the turn by turn instructions of the route that you are currently following.

If the road you are looking for is not visible press the down arrow on the right hand side of the display to see further turn by turn instructions.

Once you have found the road that you wish to avoid select it with your finger.

The unit automatically recalculates the route to your selected destination.
Once recalculation is completed the summary screen is displayed.

You can either press 'Go' to continue navigation, 'Simulation' to see the actual route, 'Route Options' to change the parameters of the route.

Navigate to – Menu

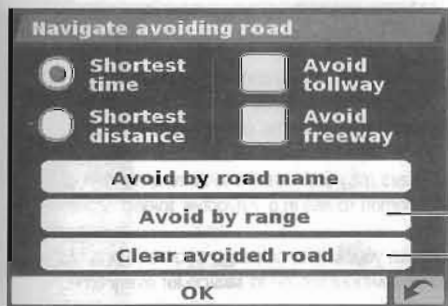

Avoid by range

If you wish to avoid several roads from the selected route plotted by the unit, then this facility allows you to re-calculate a route over a user defined distance ranging from 1mile up to a maximum 100miles.

To use this facility press the 'Avoid by range' button and the 'Select avoided range' page will be displayed.

Clear avoided road

If you do not wish to use the alternative routes offered by the unit and you wish to return to the original calculated route, press the 'Clear Avoided Road' button and the original route plotted by the unit will be restored.

Please note: If you have already travelled some of the re-calculated route, the unit may produce a slightly different route from the original plot.

The summary screen is only displayed for approximately 10 seconds before the unit automatically begins to provide you with turn by turn instructions. If the 'Avoid by Road' and 'Avoid by Range' have not been used this feature is unavailable and button will be grayed **Clear avoided road** out.

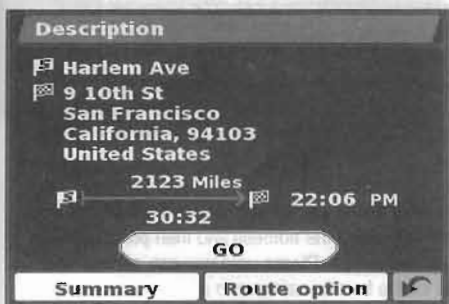

Route Description

After a route has been calculated and the journey has started you can access the summary display again by using this facility.

To view the summary screen press the center of the screen to enter the menu then press the Arrow  twice, then select the 'Route Description' icon.

In order to utilize this feature on your unit you will need to enter and calculate a route. If the Route Description icon is grayed out a route has NOT been entered.

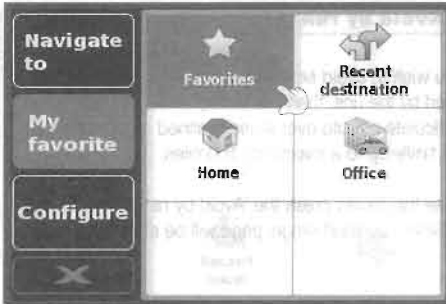

Favorites

- 1 The 'My Favorites' menu consists of the locations that you frequent visits and you want to be able to travel to without having to enter the address details each time.
- 2 Some users may find it useful to store a number of their more common routes in a 'Favorites' folder.
- 3 This allows your unit to calculate a route to one of these addresses without having to search for every time.

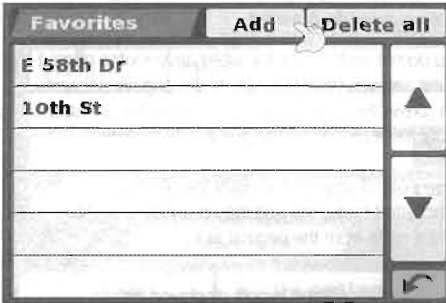

- 4 To add an address to your 'Favorites', access the Menu by pressing the center of the screen and press the **My favorite** button at the top of the display.

5 Next press the **Favorites** icon and then press **Add**.

- 6 You can now search for the address in a variety of ways as described in previous sections. Once you have found the address, simply press **Save**.



- 7 At any time during this process you can also go to a view of the map. Simply press the 'Map' button which will give you a view of a section of the map. You can now zoom in or out of the map using the **+** and **-** buttons and if you press the screen and hold your finger down you can move the map around to help you find the location you are looking for.

- 8 Once you can see the road or area, simply press the screen which will confirm the road selected. If you are happy with your selection press the **Quick menu** button and then **Continue**.

- 9 The address fields will now be completed automatically. To save these details into your 'Favorites' folder, press the 'Save' button and the new location will be added to the list.

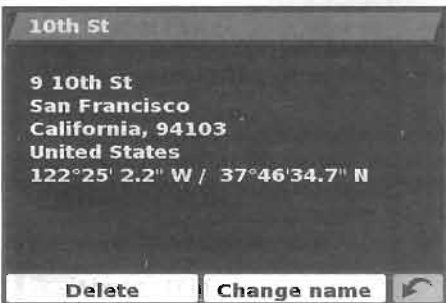

- 10 If you want to edit the name or delete the listing at any time simply select the address and then press **Delete** or **Change name**. Please note you can enter a new name for the favorite using up to a maximum of sixteen characters.

My Favorite Menu

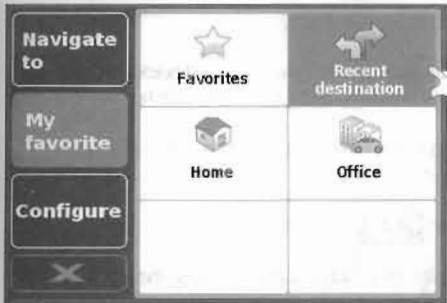

Recent destination

- 1 This function can be used to delete any or all of the recent destinations that are stored in the unit.

■ To delete individually stored Recent Destinations

Press the center of the screen to enter the menu, press the 'My Favorites' button at the top of the display and then press the  icon.

Scroll down the list of recent destinations using the up and down buttons located on the right hand side of the display and select the destinations you wish to delete.

The information relating to that destination is displayed now press the 'Delete' button at the bottom of the display. If the destination selected is not the one you wish to delete you can press the 'return; arrow'  located in the bottom right hand corner of the display to go back to the list and reselect the correct destination for deletion.

■ To delete All stored Recent Destinations

Press the center of the screen to enter the menu, press the 'My Favorites' button at the top of the display and then press the  icon.

Press the 'Delete All' button and an information box will be displayed 'Delete All?' with the options and . Press the 'OK' button and ALL the stored recent destinations will be deleted.

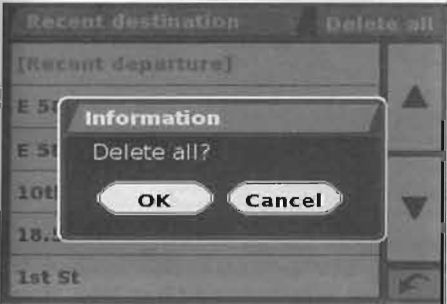

My Favorite Menu

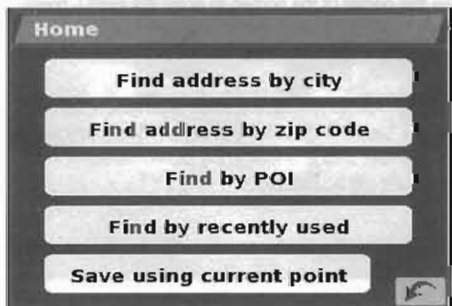
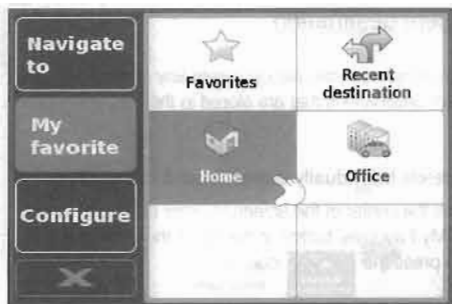

Home

- 1 Enables you to navigate easily and quickly from a previous journey or destination to your home,
- 2 Bring up the main navigation menu by pressing the center of the screen.
- 3 Press  icon at the screen.
- 4 The first time 'Home' function is used the unit will ask if you want to set your home location, press OK in the information window.
- 5 If 'Home' has already been set you will see the Information of home' so that you can change or delete home data.
- 6 You can search for your address by using one of the 5 options on the screen.
- 7 To find your home address by city, select 'Find Address by city'.
- 8 Press the 'State' and type in the states using the keyboard on the display. As you begin to input the state name, the unit will automatically prompt you with you a list of possible state names.
- 9 If you want to see the full list of it, then press the down arrow icon which is at the top-right hand corner of the screen. And use up or down arrow icon to find the state you are searching for.
- 10 When you see the state you want highlight it by pressing it with your finger. Then the unit will automatically prompt you with a City input screen. Then Street , House No. and Name input screen.
- 11 Once your unit has successfully found your address, press 'Save'. Once your home address has been saved, your unit will be able to calculate a route to this address.
- 12 To calculate a route, simply press the center of the screen to access the menu and then press the 'Home' icon. The unit will confirm the destination and offer a 'Go' button and a 'Route Option' button.
- 13 Press 'Go' and a route will automatically be created and you can personalize the route options as normal.



Office

As with the 'Home' function this unit can also save the address details of your place of work so that you can calculate a route with the minimum amount of time.

1 Bring up the main navigation menu by pressing the center of the screen.

2 Press  icon at the screen.

3 If "Office" has already been set, you will see the information of the office that you can change or delete the information you entered.

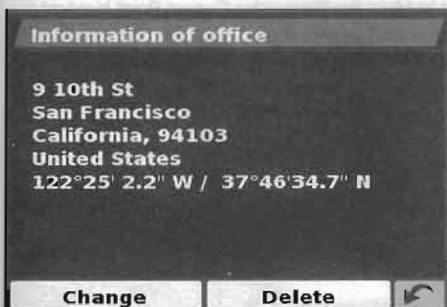

4 The first time 'Office' function is used the unit will ask if you want to set your office location, press in the information window.

5 You will see the office setting screen as shown. Next follow the instructions detailed on page 29 to add your place of work by city.

6 To add your place of work by the other menu refer to the 'Navigate to' menus. (start from page 32)

7 Again once saved, the unit will be able to calculate a route to this address in a matter of seconds.

8 To calculate a route, simply press the center of the screen to access the menu and then press the  icon.

9 A route will automatically be created and you can personalize the route options as normal.

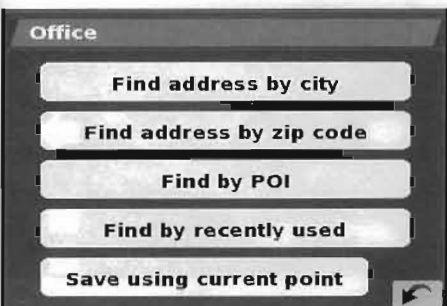



Advanced

Setting your home or office address using 'Current Coordinates' It is also possible to add these addresses using your current coordinates if you are situated at your home or office while setting up your unit.

- 1 Press the center of the screen to access the Menu, and press the **My favorite** button and press the **Home** or **Office** icon as required.

- 2 Next highlight the 'Save using Current Point' highlight a street or road by pressing on the screen the name of the road will be displayed at the bottom of the screen.

- 3 If this is correct **Quick menu** and **Continue** nally press **OK** and the unit will automatically save this location as your **Home** or **Office** destination.

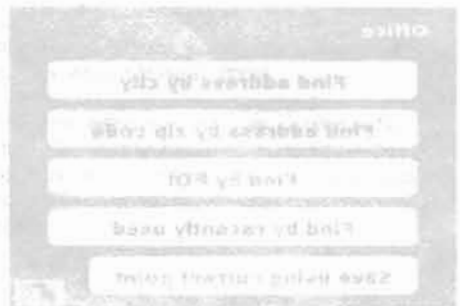

Controlling DVD Video, Video CD, JPEG or MPEG Play.

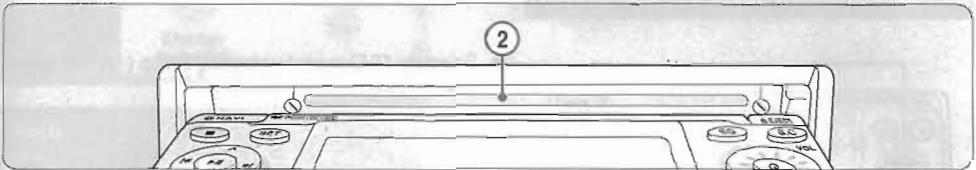
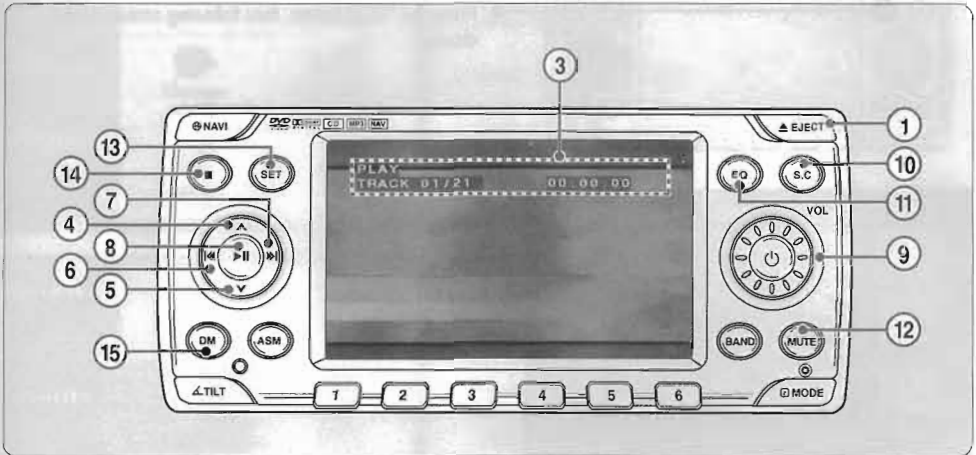

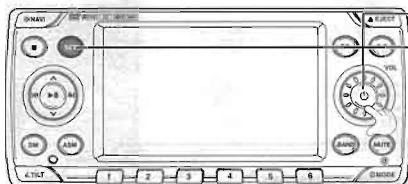

- 1 Press to eject a disc. If there is "NO DISC" on the top-left of the screen, press the Eject (▲ EJECT) button to insert a disc.
- 2 Insert a disc here. (Disc insertion slot)
- 3 Track number & Play time or Title number & Chapter number Display.
Current status is displayed for 2 seconds on the top-left of the screen such as PLAY, PAUSE, NEXT, STOP etc.
- 4 Fast forward.
The speed changes each time when it is pressed.
→ 2X → 4X → 16X → 32X → 64X → PLAY(normal speed)
- 5 Fast reversed.
The speed changes each time when it is pressed.
→ 2X → 4X → 16X → 32X → 64X → PLAY(normal speed)
- 6 Button to increase a track or chapter.
- 7 Button to decrease a track or chapter.
- 8 Pauses and replays a disc.
- 9 Adjusts the volume. Volume status is displayed from 0 to 35 on the bottom of the screen.
- 10 Selects one of the following sound condition control menu.
→ BASS → MID → TREBLE → BALANCE → FADER
Sound condition status is displayed on the bottom of the screen.
- 11 Selects one of the following equalizing menu by pressing the button.
→ CLASSIC → POP → ROCK → EQ OFF
- 12 You can turn on or off the Sound by pressing the button.
Press the button more than a second to turn on or off the NAVI AUTO CHANGE MODE.
- 13 Setup mode is selected for DVD, SCREEN or AUDIO.
Pressing the button again returns to the previous mode.
- 14 Stops a disc.
- 15 Returns to the root menu.



- Press the "Power ()" button to turn on the set.
- Press the "SET" button, then following screen will be display.



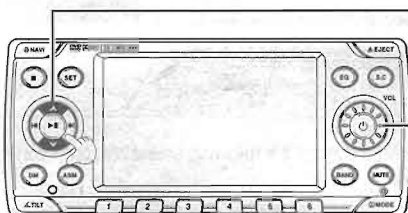

- Select the DVD mode by pressing the up () or down () button.



- or you can select up or down menu by turning the volume dial.



Also you can select by pressing () or () on the screen.

[INITIAL DVD SETUP SCREEN]

Downmix Setup



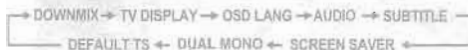

- 1 Select the Sub Menu mode by pressing the (>) or (►) button.
- 2 Then select Sub Menu that you want by pressing the (▲) or (▼) button.
- 3 Sub Menu changes each time the button is pressed from **DOWNMIX** to **DEFAULT**.



- 4 Stop at the **DOWNMIX** menu. press the (>) or (►) button. press the (▲) or (▼) button. The function changes each time the button is pressed by following turns.





- 5 Press the enter () button after you select a function. Then press the exit () button or "SET" button. It will return to the previous mode.



TV Display Setup

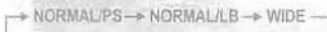

- 1 Select the Sub Menu mode by pressing the (>) or (►) button at the above initial DVD setup screen. Stop at the **TV DISPLAY** menu by pressing the down (▼) button.
 - 2 Press the (>) or (►) button. press the (▲) or (▼) button.
 - 3 The function changes each time the button is pressed by following turns.
- 
- 4 Press the enter () button after you select a function. Then press the exit () button or "SET" button. It will return to the previous mode.

■ OSD Lang Setup



- 1 Select the Sub Menu mode by pressing the (>) or (►) button at the above initial DVD setup screen. Stop at the **OSD LANG** menu by pressing the down (▼) button.
- 2 Press the (>) or (►) button. Then select the language that you want by pressing the (▲) or (▼) button.
- 3 The language changes each time the button is pressed by following turns.

```

      → ENGLISH → FRENCH → GERMAN → ITALIAN
      ← PORTUGUESE ← DANISH ← SWEDISH ←
      
```
- 4 Press the enter (◄) button after you select the language. Then press the exit (◀) button or "SET" button. It will return to the previous mode.

■ Audio Setup



- 1 Select the Sub Menu mode by pressing the (>) or (►) button at the above initial DVD setup screen. Stop at the **AUDIO** menu by pressing the down (▼) button.
- 2 Press the (>) or (►) button. Then select the language that you want by pressing the (▲) or (▼) button.
- 3 The language changes each time the button is pressed by following turns.

```

      → ENGLISH → FRENCH → SPANISH → CHINESE
      ← ITALIAN ← GERMAN ← JAPANESE ←
      
```
- 4 Press the enter (◄) button after you select the language. Then press the exit (◀) button or "SET" button. It will return to the previous mode."

■ Subtitle Setup



- 1 Select the Sub Menu mode by pressing the (>) or (►) button at the above initial DVD setup screen. Stop at the **SUBTITLE** menu by pressing the down (▼) button.
- 2 Press the (>) or (►) button. Then select the language that you want by pressing the (▲) or (▼) button.
- 3 The language changes each time the button is pressed by following turns.

```

      → ENGLISH → FRENCH → SPANISH → CHINESE
      ← ITALIAN ← GERMAN ← JAPANESE ←
      
```
- 4 Press the enter (◄) button after you select the language. Then press the exit (◀) button or "SET" button. It will return to the previous mode.





Screen Saver Setup



[SCREEN SAVER MODE]



- 1 Select the Sub Menu mode by pressing the (>) or (►) button at the above initial DVD setup screen. Stop at the **SCREEN SAVER** menu by pressing the down (▼) button.
- 2 Press the (>) or (►) button. Then select the function that you want by pressing the (▲) or (▼) button.
- 3 The function changes each time the button is pressed by following turns.



- 4 Press the enter () button after you select the function.
- 5 Then press the exit () button or "SET" button. It will return to the previous mode."
- 6 Screen saver mode will start after 1 minute when you set screen saver on.
- 7 Press the center of the screen, the "SET" button, the Play/Pause () button or FF () button to return to the previous screen.



■ Dual Mono Set up



- 1 Select the Sub Menu mode by pressing the (>) or (►) button at the above initial DVD setup screen. Stop at the **DUAL MONO** menu by pressing the down (▼) button.
- 2 Press the (>) or (►) button. Then select the function that you want by pressing the (▲) or (▼) button.
- 3 Press the enter () button to save after you select a function.
- 4 Press the exit () button.

■ Default Set up



- 1 Select the Sub Menu mode by pressing the (>) or (►) button at the above initial DVD setup screen. Stop at the **DEFAULT** menu by pressing the down (▼) button.
- 2 Press the (>) or (►) button.
- 3 Press the enter () button after you select the "RESET". Then press the exit () button or "SET" button. It will return to the previous mode.

AV1 / AV2 Control

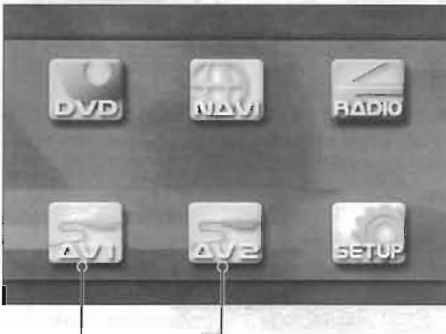
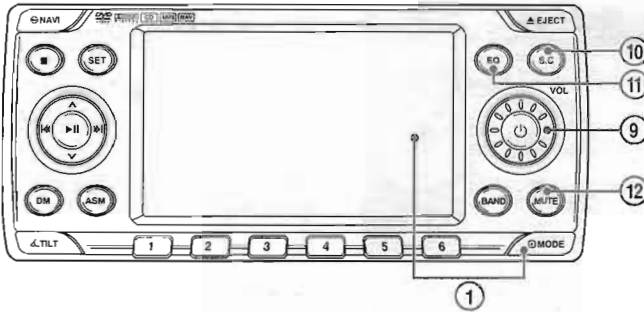

- ① Press the mode button or center of the screen. Following screen will be display with last mode already selected.

The mode changes each time when the mode button is pressed.

→ DVD → NAVI → RADIO → AV1 → AV2 → SETUP →
- ② Leave it about for 5 seconds when AV1 or AV2 is selected. Then the selected mode will be start for a moment.
- ⑨ Adjusts the volume to increase or decrease. Volume status is displayed from 0 to 35 at the button of the screen.
- ⑩ Selects one of the following sound condition control menu.

→ BASS → MID → TREBLE → BALANCE → FADER →

Sound condition status is displayed at the button of the screen.
- ⑪ Selects one of the following equalizing menu by pressing the button.

→ CLASSIC → POP → ROCK → EQ OFF →
- ⑫ You can turn on or off the Sound by pressing the button.

Tuner Control

Controlling AM, FM1, FM2 radio.

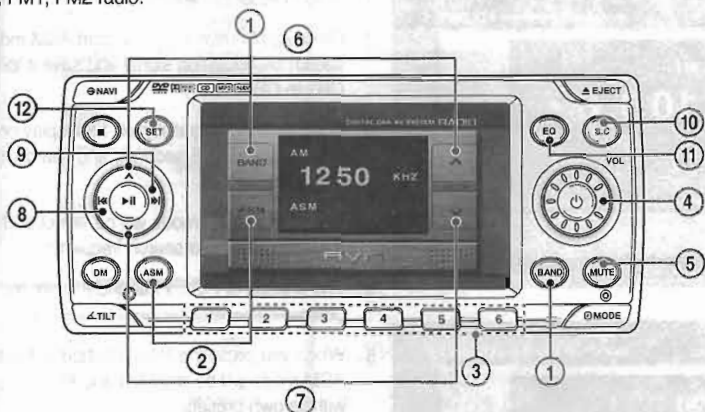

Press the preset button for more than 2 seconds when you'd like to save the channel. Then "SAVE" will be display for about 0.5 second and display channel number.



PRESET button

- ① Selects Radio mode and AM, FM1, FM2 by pressing the button.
- ② Auto frequency Search mode.
- ③ Selects a preset broadcasting station by pressing the button.
Each Radio mode(AM, FM1, FM2) have 6 preset buttons from 1 to 6.
- ④ Adjusts the volume. Volume status is displayed from 0 to 35 at the button of the screen.
- ⑤ You can turn on or off the Sound by pressing the button.
* You don't turn on/off when you play ④, ⑥, ⑦.
- ⑥ Auto search to higher freq. Broadcasting station.
- ⑦ Auto search to lower freq. Broadcasting station.
- ⑧ Manual search to higher freq. Broadcasting station.
- ⑨ Manual search to lower freq. Broadcasting station.
- ⑩ Selects one of the following sound condition control menu.
→ BASS → MID → TREBLE → BALANCE → FADER →
- ⑪ Selects one of the following equalizing menu by pressing the button.
→ CLASSIC → POP → ROCK → EQ OFF →
- ⑫ Setup mode is selected for DVD, SCREEN or AUDIO. Pressing the button again returns to the previous mode. See the "AUDIO SETUP" on page 20.



1 Auto Frequency Search Mode :

- ① Press ASM button () to start ASM mode, the unit will search broadcasting signal and save it to the preset from CH1 to CH6.
- ② The searched frequency will be display on the screen with its sound for 5 seconds and search again higher frequency up to 6.
- ③ The CH1 in ASM mode will be select and display automatically after auto search frequency.
- ④ The presets of FM1, FM2 and AM are independent each other.
- ⑤ When you press the BAND button in ASM mode, the ASM mode will be disabled and FM1 mode will be start with its own presets.
- ⑥ You can also store a frequency in ASM mode using Auto or Manual Search.



Screen Setup



Press the "SET" button, then following screen will be display.

Press the "Power (⏻)" button to turn on the set.



Select the screen mode by pressing the up (▲) or down (▼) button.

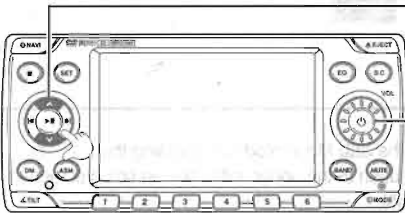

or you can select up or down menu by turning the volume dial.



Also you can select by pressing (▲) or (▼) on the screen.

[INITIAL SCREEN SETUP SCREEN]

■ Bright Setup



- 1 Select the Sub Menu mode by pressing the (>) or (►) button at the above initial screen setup screen (page 55).
- 2 Then select Sub Menu that you want by pressing the (^) or (v) button.
Sub Menu changes each time the button is pressed from BRIGHT to DIMMER.
→ BRIGHT → CONTRAST → COLOR →
- 3 Stop at the **BRIGHT** menu.
Press the (>) or (►) button.
- 4 Change the bright value by pressing the (^) or (v) button or volume dial.
The bright value changes each time the button is pressed from 1 to 50.
- 5 Press the enter (+) button after you change the bright value.
Then press the exit (■) button or "SET" button.
It will returns to the previous mode.
- 6 If you'd like to change the Sub Menu, press the (<) button or turn the volume dial.

■ Contrast Setup



- 1 Select the Sub Menu mode by pressing the (>) or (►) button at the above initial screen setup screen (page 55).
- 2 Then select Sub Menu that you want by pressing the (^) or (v) button.
Sub Menu changes each time the button is pressed from BRIGHT to DIMMER.
→ BRIGHT → CONTRAST → COLOR →
- 3 Stop at the **CONTRAST** menu.
press the (>) or (►) button.
- 4 Change the contrast value by pressing the (^) or (v) button or volume dial.
The contrast value changes each time the button is pressed from 1 to 50.
- 5 Press the enter (+) button after you select the contrast value.
Then press the exit (■) button or "SET" button.
It will returns to the previous mode.
- 6 If you'd like to change the Sub Menu, press the (<) button or turn the volume dial.



- 1 Select the Sub Menu mode by pressing the (>) or (►|) button at the above initial screen setup screen (page 55).
- 2 Then select Sub Menu that you want by pressing the (^) or (v) button.
Sub Menu changes each time the button is pressed from BRIGHT to DIMMER.
→ BRIGHT → CONTRAST → COLOR →
- 3 Stop at the **COLOR** menu.
Press the (►|) or (>) button.
- 4 Change the color value by pressing the (^) or (v) button or volume dial.
The color value changes each time the button is pressed from 1 to 50.
- 5 Press the enter (+) button after you change the color value.
Then press the exit (-|) button or "SET" button.
It will returns to the previous mode."
- 6 If you'd like to change the Sub Menu, press the (<) button or turn the volume dial.

Parking Mode

There is no screen display if you are not in parking except the NAVI , TUNER Mode or DVD Mode (AUDIO CD or MP3).

Rearview Mode

If the unit detect reargear, REARVIEW MODE will be start automatically.

Navi Auto Change Mode

Press the MUTE button more than 1 second to ON or OFF.

You can hear the NAVI sound guidance for 10 seconds even if you are not in the NAVI function.

Press the button more than a second to turn on or off the NAVI AUTO CHANGE MODE.



- Press the "Power()" button to turn on the set.
- Press the "SET" button, then following screen will be display.



- Select the **AUDIO** mode by pressing the up (^) or down (v) button.
- or you can select up or down menu by turning the volume dial.



Also you can select by pressing (^) or (v) on the screen.

If you select AUDIO menu, following screen will be display.

[INITIAL AUDIO SETUP SCREEN]

Bass Setup



- 1 Select the Sub Menu mode by pressing the (>) or (►) button at the above initial screen setup screen (page 58).
- 2 Then select Sub Menu that you want by pressing the (^) or (v) button.
Sub Menu changes each time the button is pressed from BASS to BALANCE.
→ BASS → MIDDLE → TREBLE → FADER → BALANCE
- 3 Stop at the **BASS** menu.
Press the (>) or (►) button.
- 4 Change the BASS value by pressing the (^) or (v) button or volume dial.
The BASS changes each time the button is pressed from -6 to +6.
- 5 Press the enter () button after you change the BASS.
Then press the exit () button or "SET" button.
It will returns to the previous mode."
- 6 If you'd like to change the Sub Menu, press the (<) button or turn the volume dial.



Middle Setup



- 1 Select the Sub Menu mode by pressing the (>) or (►) button at the above initial screen setup screen (page 58).
- 2 Then select Sub Menu that you want by pressing the (^) or (v) button.
Sub Menu changes each time the button is pressed from BASS to BALANCE.
→ BASS → MIDDLE → TREBLE → FADER → BALANCE
- 3 Stop at the **MIDDLE** menu.
press the (>) or (►) button.
- 4 Change the middle by pressing the (^) or (v) button or volume dial.
The middle changes each time the button is pressed -6 to +6.
- 5 Press the enter () button after you select the middle.
Then press the exit () button or "SET" button.
It will returns to the previous mode.
- 6 If you'd like to change the Sub Menu, press the (<) button or turn the volume dial.



Treble Setup



- 1 Select the Sub Menu mode by pressing the (>) or (►) button at the above initial screen setup screen (page 58).
- 2 Then select Sub Menu that you want by pressing the (▲) or (▼) button.
Sub Menu changes each time the button is pressed from BASS to BALANCE.
→ BASS → MIDDLE → TREBLE → FADER → BALANCE
- 3 Stop at the **TREBLE** menu.
press the (>) or (►) button.
Change the treble value by pressing the (▲) or (▼) button or volume dial.
The treble value changes each time the button is pressed from -6 to +6.
- 5 Press the enter () button after you select the treble value.
Then press the exit () button or "SET" button.
It will returns to the previous mode."
- 6 If you'd like to change the Sub Menu, press the (<) button or turn the volume dial.

Fader Setup



- 1 Select the Sub Menu mode by pressing the (>) or (►) button at the above initial screen setup screen (page 58).
- 2 Then select Sub Menu that you want by pressing the (▲) or (▼) button.
Sub Menu changes each time the button is pressed from BASS to BALANCE.
→ BASS → MIDDLE → TREBLE → FADER → BALANCE
- 3 Stop at the **FADER** menu.
Press (>) or (►) button.
- 4 Change the fader value by pressing the (▲) or (▼) button or volume dial.
The fader value changes each time the button is pressed from -8 to +8.
- 5 Press the enter () button after you select the fader value.
Then press the exit () button or "SET" button.
It will returns to the previous mode.
- 6 If you'd like to change the Sub Menu, press the (<) button or turn the volume dial.



- 1 Select the Sub Menu mode by pressing the (>) or (►) button at the above initial screen setup screen (page 58).
- 2 Then select Sub Menu that you want by pressing the (▲) or (▼) button.
Sub Menu changes each time the button is pressed from BASS to BALANCE.
→ BASS → MIDDLE → TREBLE → FADER → BALANCE →
- 3 Stop at the **BALANCE** menu.
Press the (>) or (►) button.
- 4 Change the balance by pressing the (▲) or (▼) button or volume dial.
The balance changes each time the button is pressed from -8 to +8.
- 5 Press the enter (◻) button after you select the balance.
Then press the exit (-) button or "SET" button.
It will returns to the previous mode.
- 6 If you'd like to change the Sub Menu, press the (<) button or turn the volume dial.

Installation Procedure

- 1 To prevent a short circuit, remove the key from the ignition and disconnect the negative post(-) battery.
- 2 Make the proper input and output wire connections for each unit.
- 3 Connect the speaker wires of the wiring harness.
- 4 Connect the wiring harness wires in the following order: ground, battery, ignition.
- 5 Connect the wiring harness connector to the unit.
- 6 Install the unit in your car.
- 7 Reconnect the negative post(-) battery.
- 8 Press the hardware reset button.

▲ WARNING

- Do not connect the ignition wire and the battery wire to the car chassis(ground) ,you may cause a short circuit, that in turn may start a fire. Always connect those wires to the power source running through the fuse box.
- Do not cut out the fuse from the ignition wire and the battery wire. The power supply must be connected to the wires via the fuse.

▲ CAUTION

- If your car's ignition does not have an ACC position, connect the ignition wires to a power source that can be turned on and off with the ignition key. If you connect the ignition wire to a power source with a constant voltage supply, as with battery wires, the battery may die.
- If the console has a lid, make sure to install the unit so that the faceplate will not hit the lid when closing and opening
- If the fuse blows, first make sure the wires aren't touching to cause a short circuit, then replace the old fuse with one with the same rating.
- Insulate unconnected wires with vinyl tape or other similar material. To prevent al short circuit, do not remove the caps on the ends of the unconnected wires or the terminals.
- Connect the speaker wires correctly to the terminals to which they correspond. The unit may be damaged or fail to work if you share the "-" wires or ground them to any metal part in the car.
- When only two speakers are being connected to the system. Connect the connectors either to both the front output terminals or to both the rear output terminals(do mot mix front and rear). For example, if you connect the "+" connector of the left speaker to a front ouput terminal, do not connect the - connector to a rear ouput terminal.
- After the unit is installed, check wheather the brake lamps, blinkers, wipers, etc. on the car are working properly.
- Mount the unit so that the mounting angle is 30' or less.

How to install

10



01 Unpack the GIFT BOX.



02 Detach the unit from the Half Sleeve.

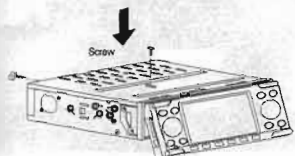

03 Remove the safety screw for transporting which is on the top of the unit.



04 Front dash board



05 Source the 'Half Sleeve' by bending the metal tabs. downward



06 Insert the into Dash Board.



06-1 Set installed

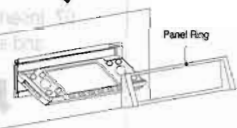

07 Insert the 'Panel Ring' into the slot between Dash board and set.

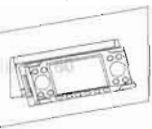

08 Installation is finished.

How to install



01 Unpack the GIFT BOX.



02 Detach the unit from the Half Sleeve.



03 Remove the safety screw for transporting which is on the top of the unit.

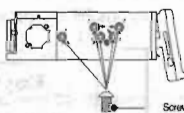

04 Screw a not provided to the right and left side of the set.

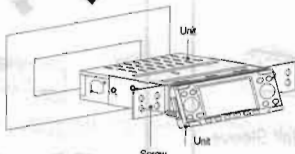

05 Screw the Dash board.



06 Set installed

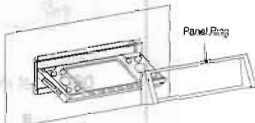

07 Insert the 'Panel Ring' into the slot between Dash board and set.

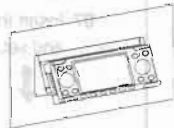

08 Installation is finished.

How to Remove

01

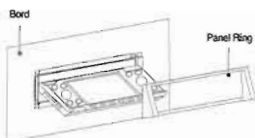

01 Detach the 'Panel Ring' from the front panel.

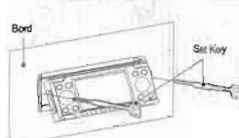

02 Insert the 'Set Key' into the slot between dash board and of the both side of the unit, left and right.

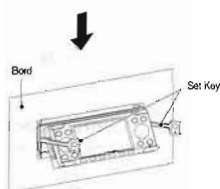

03 Insert the 'Set Key' deeply into the centerslot of left and right hand side of the unit.

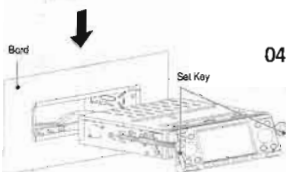

04 Detach the set key from the dash board at the same time.

02



01 Detach the 'Panel Ring' from the front panel.

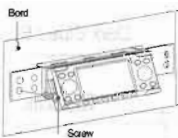

02 Unscrew the form dash board.

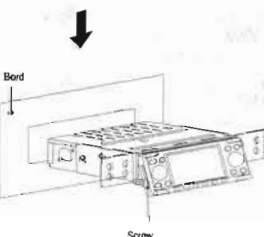

03 Unscrew the bracket from the left hand side and right hand side of the unit.

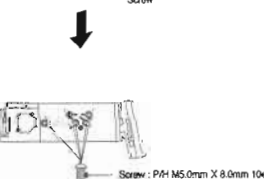

04 Detach the set key from the dash board at the same time

Screw : PH M5.0mm X 8.0mm 10ea

OUTPUT connection

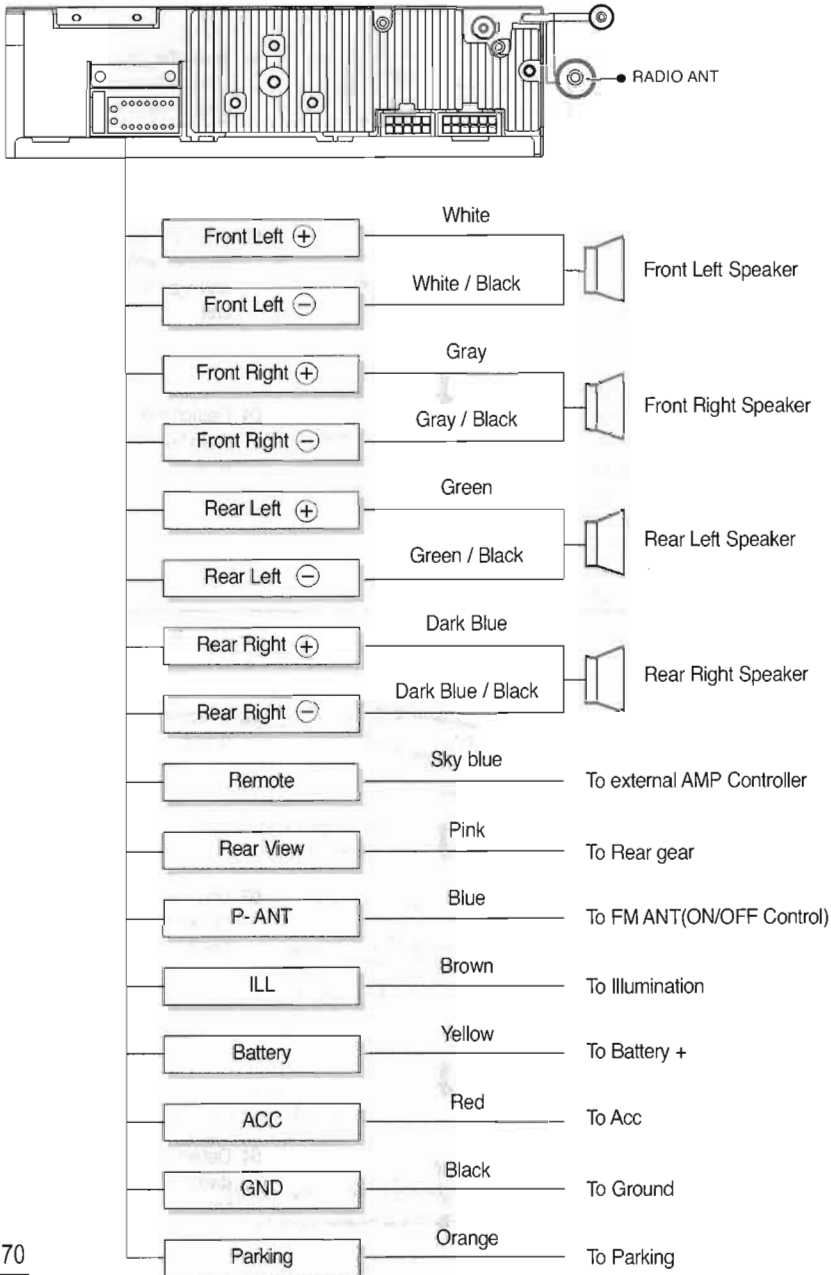

System Connection

GLASSON

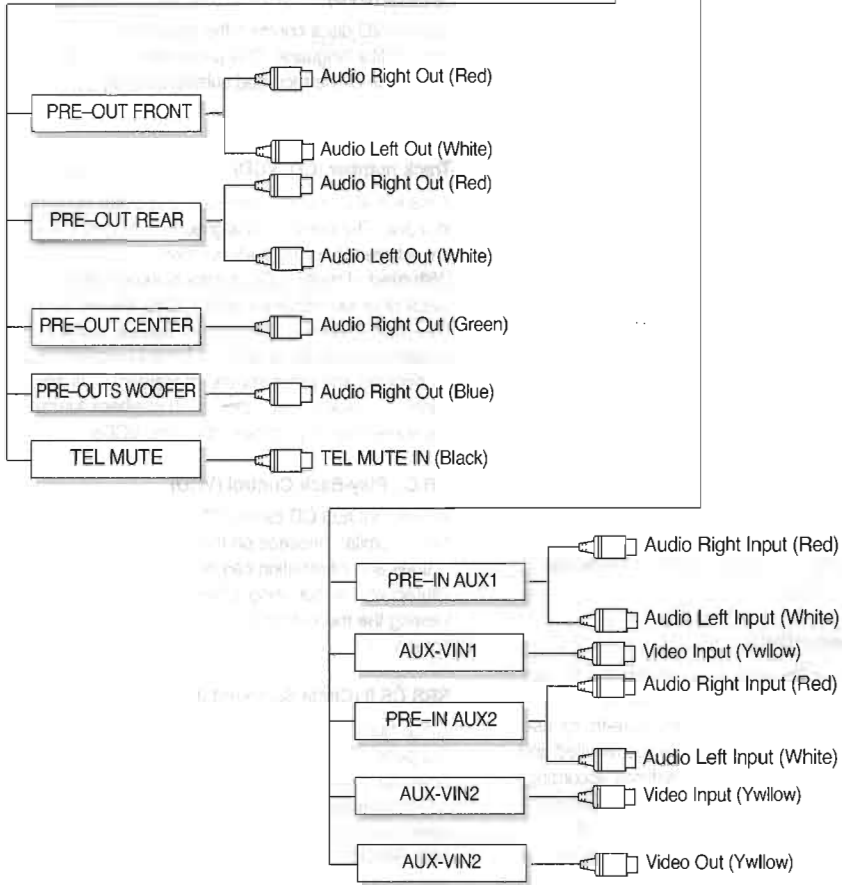
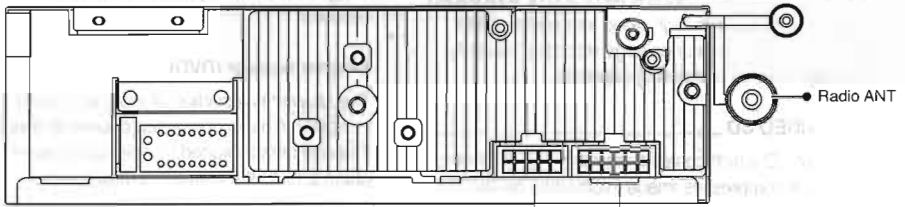

DVD: Digital Versatile Disc

A type of disc which contains recording of audio/video packaged media with high video and audio quality, such as a movie, featuring large recording capacity and digital signal processing capability.

VCD: VIDEO CD

A type of CD which contains the recording of moving images. It compresses image information by about 1/120 and audio information by about 1/6 and accommodates up to 74 minutes of recording in a disc with the same diameter as ordinary music CD of 12 cm.

Some VCDs do not have the P.B.C. compatibility and are capable of playback only, while some are P.B.C. compatible and are capable of various special play back control operations. This player can play both of these VCDs.

MPEG: Moving Picture Experts Group

This is an international standard for digital video and audio compression and decompression in media.

Dolby Digital

This is a digital audio compression technology developed by Dolby Laboratories. It is compatible with 5.1-channel surround audio as well as normal stereo (2-channel) audio and can accommodate a large amount of audio data efficiently in a disc.

DTS

Name of a digital surround system developed by Digital Theater Systems, Inc.

Top menu/menu (DVD)

Some DVDs display more than one title in a screen. This screen is referred to as the top menu.

The menu is the item display (menu screen) for use in setting operations. The menu can be recalled and time during play back to perform settings according to the current software, including the audio switching between Dolby Digital and PCM, switching of language used in the subtitles and spoken voice.

Title number (DVD)

The title is the largest unit of video and audio recorded in a DVD. It usually corresponds to a single movie of video software or an album (sometimes a

piece of music) of music software. The numbers assigned to individual title are referred to as the title numbers.

Chapter number (DVD)

The chapter is a section of video and audio recorded in a DVD. A title is composed of several chapters. The numbers assigned to individual chapters are referred to as the chapter numbers.

Subtitle (DVD)

Some DVD discs contains the recording of more than one subtitle language. This player allows you to select one of the recorded subtitle languages during playback.

Track number (CD, VCD)

A track is also a section of video and audio recorded in a disc. The numbers assigned to individual tracks are referred to as the track numbers.

With most of music CDs, a track is assigned to a piece of music. However, with a VCD, the sections of the contents do not always correspond to the assigned tracks. As (special) playback functions such as skipping and programming of ordinary CDs are based on track number data, such playback functions are sometimes impossible with some VCDs.

P.B.C.: Play-Back Control (VCD)

When a VIDEO CD carries "Play Back Control capable" or similar message on the disc or jacket, desired scenes and information can be played back in an interactive manner using a hierarchical structure while viewing the menu screens displayed on the TV screen.

SRS CS II (Circle Surround II)

Circle Surround II improves on its predecessor Circle Surround (CS5.1) by enabling you to experience powerful multi-channel surround sound playback from mono, stereo or Dolby surround encoded audio and video sources.

With SRS CS II you can also listen to audio CDs, television and radio broadcasts in full surround sound. You will discover a new type of sound experience through SRS CS II.

Troubleshooting Guide

What might appear to be a malfunction in your unit may just be the result of slight misoperation or misfiring. Before calling service, first check the following table for possible problems.

General

The power does not turn on.

- The fuse has blown.
After checking for short circuits in the wires, replace the fuse with one having the same rating.
- The speaker wire has a short-circuit or touches the chassis of the vehicle, and then the protection function is activated.
Wire or insulate the speaker cable properly and press the reset button.

Nothing happens when the buttons are pressed.

- The computer chip in the unit is not functioning normally.
Press the reset button on the unit.

No television/video image appears.

- The unit is not connected to the parking brake detection switch.
Make proper connections according to <INSTALLATION >
- The parking brake is not engaged.
For safety reasons no television/video images are displayed while the vehicle is moving.
Engaging the parking brake will cause images to be displayed.

The screen is dark.

- The unit is in a location where temperature is low.
If the temperature of the monitor unit drops, the screen may appear darker when power is first turned on due to the characteristic of a liquid crystal panel. Wait a while after turning power on for the temperature to rise. Normal brightness will return.

The screen does not darken when the vehicle's lights are turned on.

- The unit is set to auto dimmer.
When the unit is set to auto dimmer, it is not linked to the vehicle's light switch.

AM/FM radio reception is poor and/or there is noise.

- The TV antenna and vehicle's radio antenna are too close.

Separate the two antennas as possible.
Turn Off the main unit.

The remote controller does not operate.

- The remote control mode selector is not set correctly.
Switch the remote control mode selector according to the source you select page 8.

No sound can be heard, or the volume is low.

- The fader or balance settings are set all the way to one side.
Reset the fader and/or balance settings.
- The input/output wires or wiring harness are connected incorrectly.
Reconnect the input/output wires or the wiring harness correctly.
See the section on<INSTALLATION>

The sound quality is poor or distorted.

- One of the speaker wires is being pinched by a screw in the car.
Check the speaker wiring.
- The speakers are not wired correctly.
Reconnect the speaker wires so that each output terminal is connected to a different speaker.

Radio reception is poor.

- The car antenna is not extended.
Pull the antenna out all the way.
- The antenna control wire is not connected.
Connect the wire correctly, referring to the section on <INSTALLATION>

The memory is erased when the ignition is turned off.

- The battery wire has not been connected to the proper terminal.
Connect the wire correctly, referring to the section on <INSTALLATION>
- The ignition and battery wire are incorrectly connected.
Connect the wire correctly, referring to the section on <INSTALLATION>

The sound/picture skips on a DVD/VCD/CD.

- The disc is scratched or dirty.

Troubleshooting Guide

Clean the disc, referring to the section on disc cleaning.

A track will not play.

- Random play has been selected.
Turn off random play.

A VCD cannot be played using menus.

- The VCD disc being played is not compatible with P.B.C..
Menu playback is available only with VCD discs recorded with P.B.C..

The subtitle is not displayed.

- The DVD disc being played does not contain the recording of subtitles.
- The subtitle cannot be displayed when the DVD disc being played does not contain the recording of subtitles.

The voice (or subtitle) language cannot be changed.

- The DVD disc being played does not contain the recording of more than one audio (or subtitle) language.
- The voices (or subtitle) language cannot be changed when the DVD disc being played does not contain the recording of more than one voice (or subtitle) language.

The viewing angle cannot be changed.

- The DVD disc being played does not contain the recording of more than one angle.
The viewing angle cannot be changed when the DVD disc being played does not contain the recording of more than one angle.
- You are attempting to switch the angle in a DVD section where more than one angle is not recorded.
More than one viewing angle may be recorded only in limited sections in a disc.

Playback will not start even after a title is selected.

- A viewing restriction (RATING) has been set for the disc.
Check the viewing restriction level (RATING) setting.

The voice or subtitle language selected in the initial setting is not played.

The DVD disc being played does not contain the recording of the selected voice or subtitle language. Use a DVD disc containing the recording of the selected voice or subtitle language.

Disc source

The disc control mode cannot be selected.

- No wire has been connected to the disc changer input terminal on the unit.
Connect the wire to the disc changer input terminal on the unit.

The specified disc does not play, but another one plays instead.

- The specified CD is quite dirty.
Clean the CD.
- The CD is upside-down.
Load the CD with the labeled side up.
- The disc is loaded in a different slot from that specified.
Eject the disc magazine and check the number for the specified disc.
- The disc is severely scratched.
Try another disc instead.

The sound skips.

- The CD is scratched or dirty.
If skipping happens at the same place when the car is stopped, something with the CD is wrong.
Clean the CD.

The specified track will not play.

- Random play or magazine random play has been selected.
Turn off random play or magazine random play.

Cannot remove disc.

- The cause is that more than 10 minutes has elapsed since the vehicle ACC switch was turned OFF. The disc can only be removed within 10 minutes of the ACC switch being turned OFF. If more than 10 minutes has elapsed, turn the ACC switch ON again press the Eject button.

FCC (Federal Communications Commission)

Note

This equipment has been tested and found to comply with the limits for a Class B digital device, pursuant to part 15 of the FCC Rules. These limits are designed to provide reasonable protection against harmful interference in a residential installation. This equipment generates, uses and can radiate radio frequency energy and, if not installed and used in accordance with the instructions, may cause harmful interference to radio communications. However, there is no guarantee that interference will not occur in a particular installation. If this equipment does cause harmful interference to radio or television reception, which can be determined by turning the equipment off and on, the user is encouraged to try to correct the interference by one or more of the following measures:

- * Reorient or relocate the receiving antenna.
- * Increase the separation between the equipment and receiver.
- * Connect the equipment into an outlet on a circuit different from that to which the receiver is connected.
- * Consult the dealer or an experienced radio/TV technician for help.

Modifications not expressly approved by the manufacturer could void the user's authority to operate the equipment under FCC rules.

Troubleshooting Guide

MP3/WMA source

Cannot play an MP3/WMA,

- The media is scratched or dirty.
Clean the media, referring to the Disc cleaning of the section on.

The sound skips when an MP3/WMA is being played.

- The media is scratched or dirty.
Clean the media, referring to the Disc cleaning of

the section on.

- The recording condition is bad.
Record the media again or use another media.

The MP3/WMA track time is not displayed correctly.

- ---
Record in conformity with the ID3 tag version 1.x.
Also, the display may be incorrect if an MP3/WMA file uses the ID3 tag v1.x standard and if this standard has been expanded after production of the machine software.

TROUBLE

- No Power _____
- No Picture _____
- Stopped picture _____
- The playback picture is poor. _____
- No color. _____
- The remote control doesn't work properly. _____
- ERROR-DISC is displayed on the screen. _____
- ERROR-DISC Check Regional Code is displayed on the screen. _____
- No function with the remote control. _____
- Unable to insert Disc. _____
- No Function With all buttons on the unit & remote control. —
- Check Point. _____

CORRECTIVE ACTION

Check that DC power cable is connected properly.

1. Make sure that the equipment is connected properly.
2. Check that the connected monitor is turned on.

1. Check that the video cable is connected.
2. Check that the monitor is turned on.

Clean the disc

Adjust the video system by changing TV output mode (AUTO, PAL, NTSC)

Remove any obstacles between the remote controller and remote control sensor of the unit. Operate the remote control at a closer distance to the unit.

1. Turn the power off, then turn it on.
2. Turn the power off, disconnect the power plug, then reconnect it.

Check in which region the DVD Disc can be played. The DVD Disc is not available of the region code of the DVD Disc is not in conformity to the one of the unit.

Check the batteries and make sure that the batteries are fresh & new, or have enough battery life.

1. Check if the protection screw was removed before installation of the unit. (Only at the first insertion after installation.)
2. Pull out Disc and wait for 3 seconds, and insert Disc again.

Press the Hard Reset Key.

When a disc is brought from a cold environment to a hot one, there may be steam on the face of the disc, or water will appear on the pickup lens. it will affect the play.

1. Remove the disc from the DVD player.
2. Turn on the power and leave it on for an hour to vaporise the condensation.

Specifications

DVD&Monitor

Video display system	NTSC (PAL available)
Display Screen	TFT-LCD 16:9 Aspect Ratio
Element	TFT-LCD / Active Matrix
Format	VGA 800(W) x 480(H) x 3
Back Light	LED Driver
Audio Input Level	2.0 Vrms(max)
Audio Output Level	800mV(Fixed)
Video Input/Output Level	1+_ 0.1Vp-p (75 ohms)
Video/Signal to Noise Ratio	60 dB
CD Dynamic Range	93dB (at 1kHz)
CD Frequency Response	20Hz - 20kHz (\pm 1dB)
Channel Separation	-80dB or More
DAC Resolution	24 Bit (Max)
DVD Dynamic Range	90dB (at 1kHz)
DVD Freq. Response(48kHz Sampling)	20Hz - 22kHz (\pm 1dB)
DVD Freq. Response(96kHz Sampling)	20Hz - 44kHz (\pm 1dB)
Total Harmonic Distortion(THD)	Less than 0.2% (1KHz, 2V rms)
EMC (FCC Class B)	-3dB Margin
Shock Proof	All band 1G or More
Operating Temperature	-20°C to +70°C
Storage Temp.	-40°C to +85°C
Power Requirement	11 - 16 Volts DC

Embedded Processor : Intel PXA255

400MHz ARM 9

Memory

On Board SDRAM 64MB

On Board NAND FLASH 64MB for OS & MAP Application

GPS Antenna

Module : SiRF III one Chip (AV), UART
communication to Navi Board

ANTENNA : External Active ANT, External AV set
installation

LCD Module

Wide TFT LCD, 16:9

(320*234) Resolution, RGB stripe pixel, 24bit parallel 6 O'clock view direction

Temp : -10°C ~ +60°C/-20°C ~ +70°C (-20°C ~+70°C/-40°C ~ +85°C)

GPS SiRF III

12 Parallel tracking channel

L-1 Band, C/A code, NMEA-0183 compatible

Sensitivity -172dBW

Position Accuracy : 7~15cm with SA(No WAAS 2~7m supported)

Storage Device

One SD Card Slot

NAVI Ver. 1.0.0.1