

# OWNER'S MANUAL

## 10.4" TFT-LCD SCREEN CEILING MOUNT MONITOR

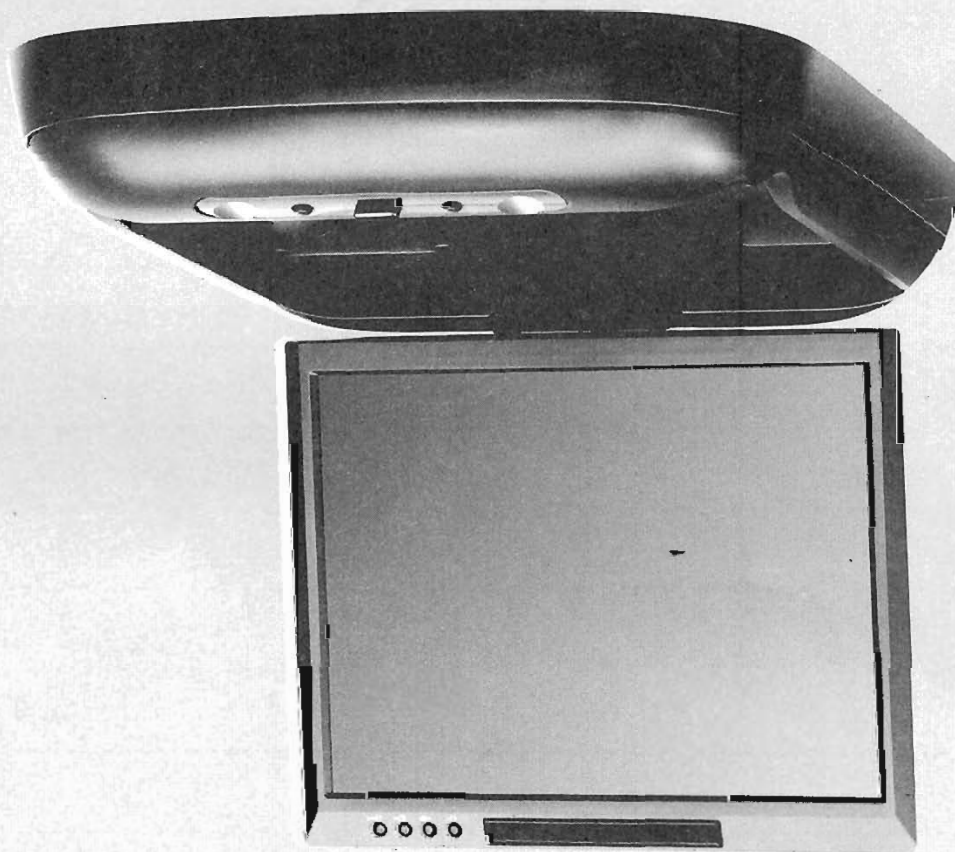

### CAUTION

Changes or modifications not expressly approved by the party responsible for compliance could void the user's authority to operate the equipment.

# CONTENTS

Thank you for purchasing one of our products!  
please read the entire users manual prior to installing this product!

<b>CAUTION</b> .....	4-5
<b>NAME AND FUNCTION OF EACH PARTS</b> .....	6-7
- Unit .....	6
- Remote Controller .....	7
<b>HOW TO OPERATE THE MONITOR</b> .....	8
- Releasing The Monitor .....	8
- How To Watch Monitor .....	8
<b>PICTURE CONTROL</b> .....	9
- Auto Picture Control .....	9
- Manual Picture Control .....	9
<b>EXTRA FUNCTIONS</b> .....	10-11
- FM TX .....	10
- POWER .....	11
- RESET .....	11
<b>CONNECTION DIAGRAM</b> .....	12
<b>SPECIFICATIONS</b> .....	13

# CAUTION

Please read and observe all warnings and instructions in this owner's manual and those marked on the unit. Retain this booklet for future reference.

There are two kinds of alarm symbols as follows:



The lightning flash with arrowhead symbol within an equilateral triangle is intended to alert the user to the presence of "dangerous voltage" within the product's enclosure that may be of sufficient magnitude to constitute a risk of electric shock to people.



The exclamation point within an equilateral triangle is intended to alert the user to the presence of important operating and maintenance (servicing) instructions in the literature accompanying the product.

## WARNING



Installation of all TV monitors must be out of the driver's field of sight.



Do not mount the product where it will obstruct the deployment of the airbag or in an area where it would affect the vehicular control. Also be careful to avoid mounting the product where it can become hazardous during sudden stops or in the event of an accident.



Do not try and service these products yourself, seek only a qualified service center or factory service center.



Use extra caution with any liquids in your car. If you or your child spill any liquid on these products, pull your vehicle to the roadside and turn the key off to disconnect or wipe the products with a towel. Do not operate the equipment until all liquids have either evaporated or you have had the monitor inspected at a service center by a qualified technician. Severe harm or danger can be occurred.



Be careful not to drop or apply under pressure to the front panel of your video monitor. If the screen cracks due to misuse, your warranty will be void!



Be careful not to overload your cigarette lighter plug by adding more than one device at a time.



Use only a damp cloth to clean the screen and use only purified water on the cloth, wring out all excess water prior to wiping the screen. Do not use any cleaners or chemicals to clean the screen. In most cases a dry cloth will do!

# CAUTION

## CAUTION



Quality installations are best performed by qualified and certified installers.



Watching the monitor for an extended period of time without the engine running may deplete the vehicle's battery charge.



Don't touch the unit there is a flash of lightning. It may receive an electric shock.



This product is designed for operation with a 12 Volt DC, negative ground vehicle. It is not suitable for operation under other conditions or voltages.



Do not cover or stop up heater ducts or vents. It may be the origin of a fire or receives an electric shock.

## Check Point

1. The operating temperature of this product is limited to  $-4^{\circ}\text{F} \sim +176^{\circ}\text{F}$ . Your vehicle can reach temperatures up to  $212^{\circ}\text{F}$  in the summertime.
2. From time to time when your vehicle is extremely hot or cold you must allow time for your air conditioner or heater to cool or heat the vehicle and for operating temperatures to return to normal operating ranges. Your monitor will return to its normal functions when these operating ranges are achieved.
3. Your optimum picture quality is achieved when you are directly in front of the monitor ( $\pm 30$  degrees).

# NAME AND FUNCTION OF EACH PARTS

## Unit

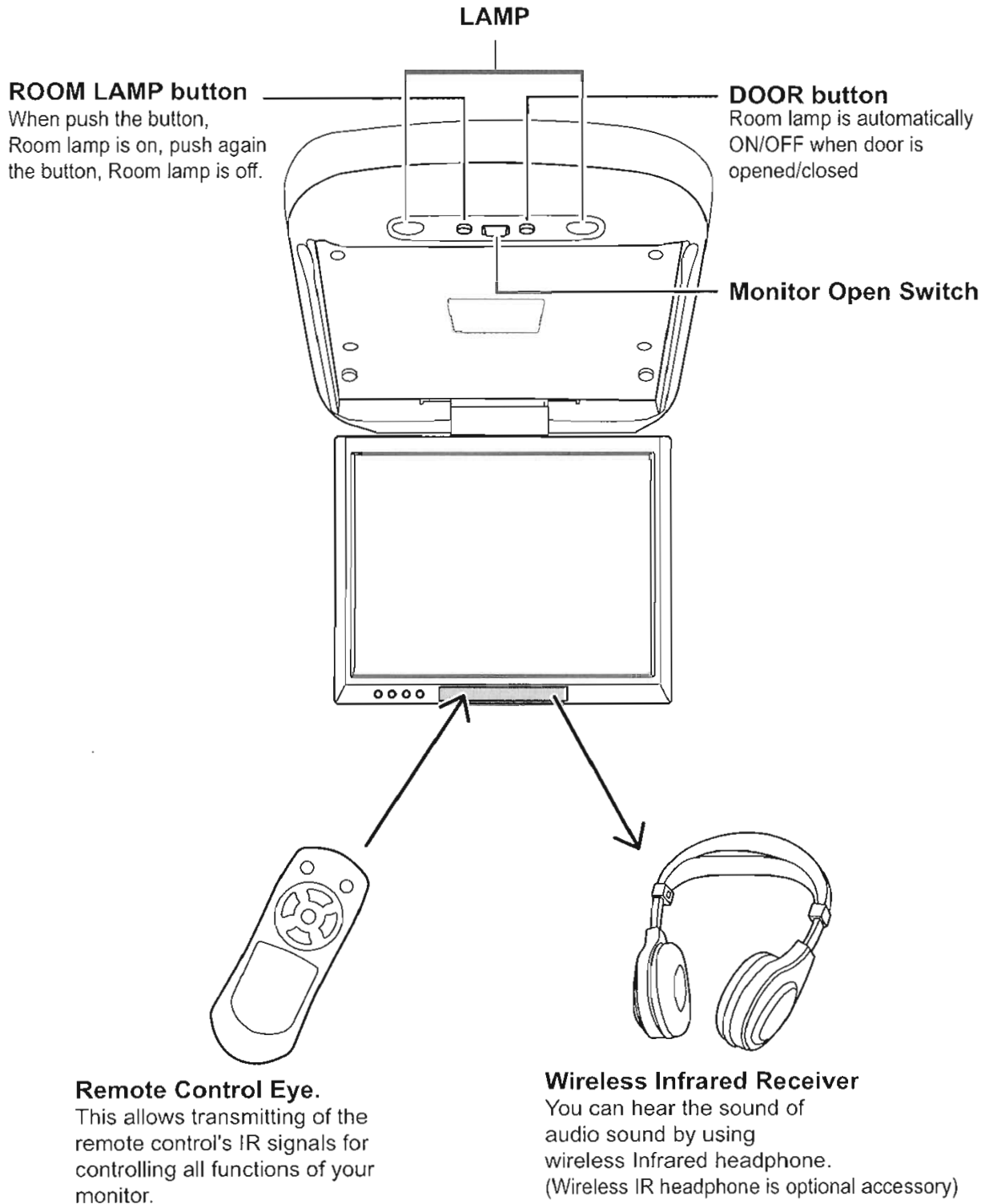

# NAME AND FUNCTION OF EACH PARTS

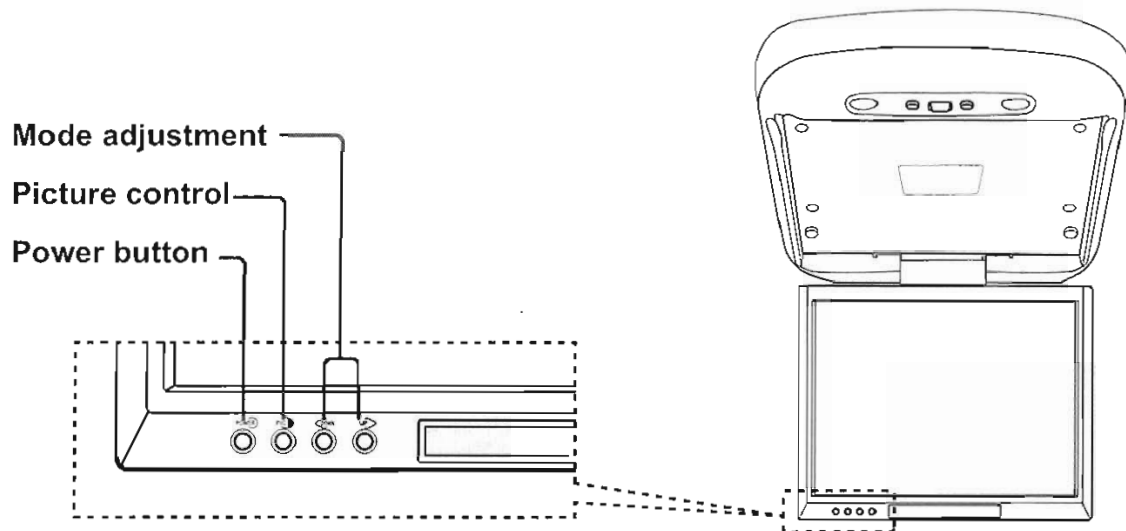

## Remote Controller

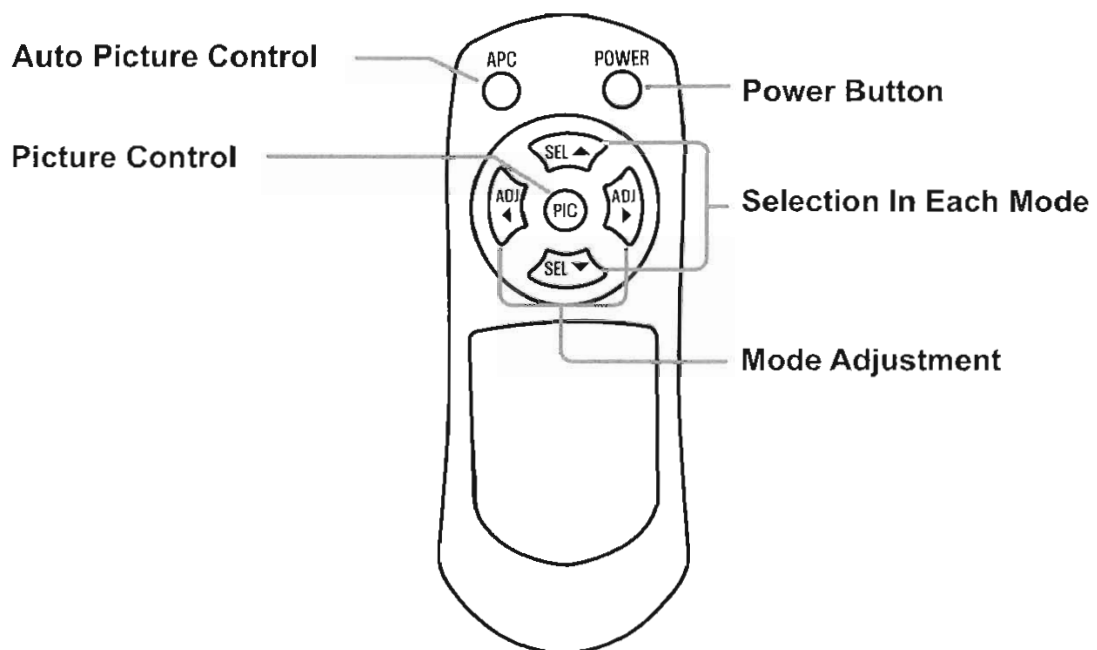

# HOW TO OPERATE THE MONITOR

## Releasing The Monitor

Push the open button (located on the front of your screen) and lower the monitor to the desired level. You can also adjust the swivel angle.

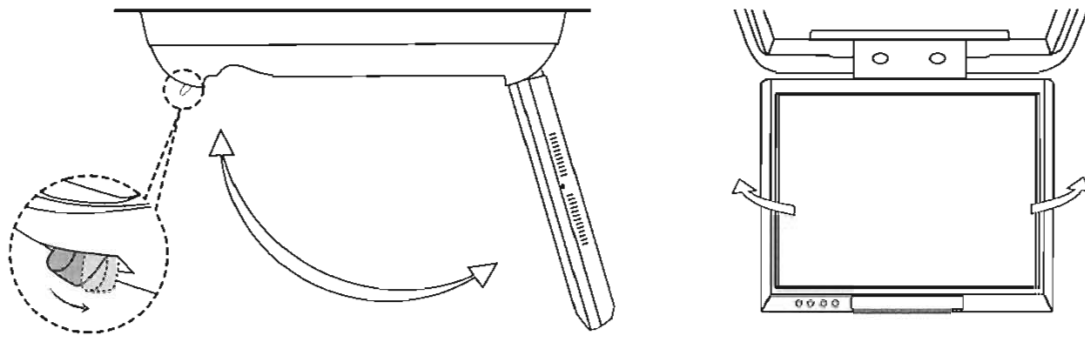

※ When closing the displayed monitor on the ceiling mount, it will automatically be turned off. When opening the monitor again, it will automatically be turned on.

## How To Watch Monitor

1. Connect the monitor to external devices.
2. Press the **POWER** button on either the remote control or the unit once to turn the power on.  
Press the same **POWER** button to turn the power off.

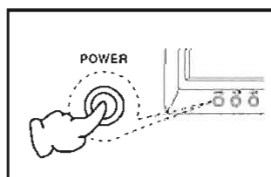

UNIT

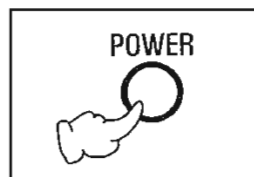

REMOTE CONTROL

3. Power on the external devices and play.

# PICTURE CONTROL

## Auto Picture Control



Press this button to change picture mode.  
When you press this **APC** button, Picture mode will be changed as follows;

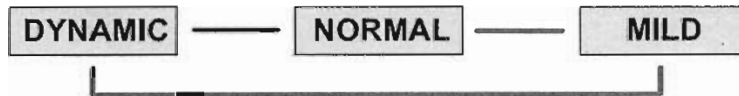

## Manual Picture Control (Contrast, Bright, Color or Tint selections:)

Use to achieve the desired settings.

1. Bring up the on-screen picture control menu by pushing the **PIC** button on the remote control or unit.

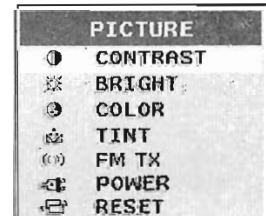

2. Select **CONTRAST/BRIGHT/COLOR/TINT** you want to control by pushing the **SEL V/Λ** buttons on the remote control.

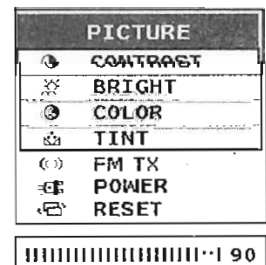

3. Adjust the picture conditions with the **ADJ </>** buttons on the remote control or the **DOWN/UP** buttons on the unit to achieve the desired settings.

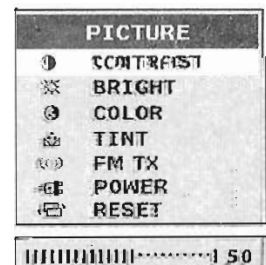



# EXTRA FUNCTIONS

## FM TX

Listening to the audio portion of the disk through your automotive speakers.

1. Bring up the on-screen picture control menu by pushing the **PIC** button on the remote control or unit.

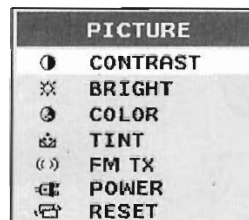

2. Select the **FM TX** menu by pressing the **SEL V/Λ** buttons on the remote control.

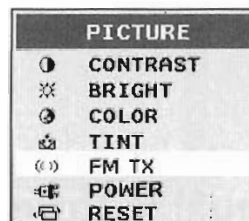

88.5MHz

3. Adjust the Radio frequency from **88.3MHz~90.1MHz** by pressing the **ADJ </>** buttons on the remote control or the **DOWN/UP** buttons on the unit to achieve the desired settings.

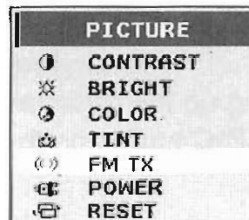

88.3MHz

4. After setting the Radio frequency, control the radio volume.



- ※ When **FM TX** is not working, you can hear the sound through **IR headphone**.  
(IR headphone is optional items)

# EXTRA FUNCTIONS

## POWER

1. Bring up the on-screen picture control menu by pushing the **PIC** button on the remote control or unit.

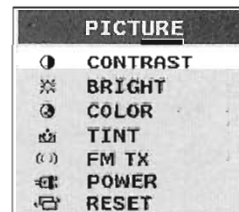

2. Select the **POWER** menu by pressing the **SEL V/Λ** buttons on the remote control.

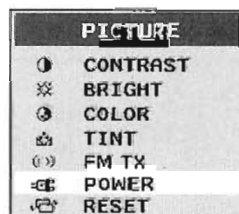

MEMORY OFF

3. Adjust the **POWER** mode you want by pressing **ADJ </>** buttons on the remote control or the **DOWN/UP** buttons on the unit.

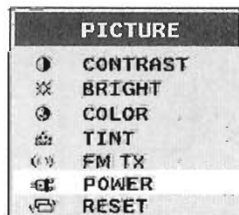

MEMORY ON

## RESET

This Function will reset the same as factory setting conditions.

1. Bring up the on-screen picture control menu by pushing the **PIC** button on the remote control or unit.

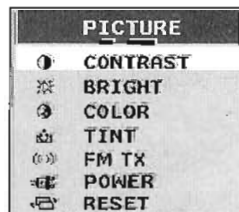

2. Select the **RESET** menu by pressing the **SEL V/Λ** buttons on the remote control.

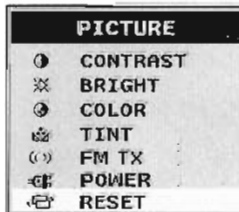

3. Reset the all functions with the **ADJ </>** buttons on the remote control or the **DOWN/UP** buttons on the unit.

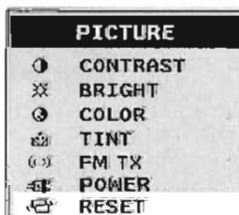

# CONNECTION DIAGRAM

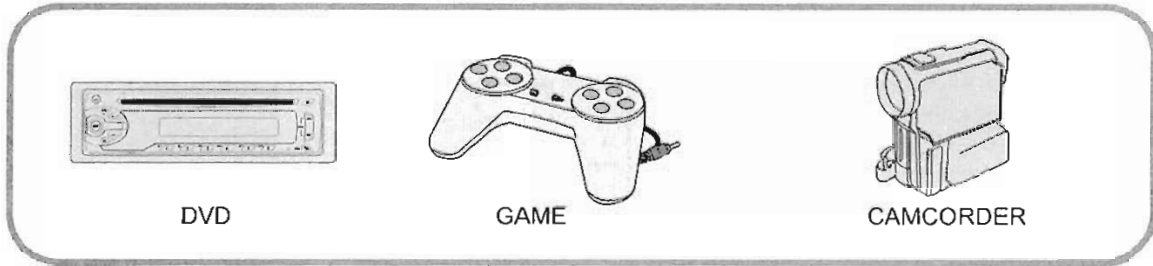

YELLOW VIDEO  
WHITE AUDIO(L)  
RED AUDIO(R)

+12V (RED)  
GND (BLACK)

BLACK (GROUND)  
BLUE (DOOR LAMP)  
RED (12V)

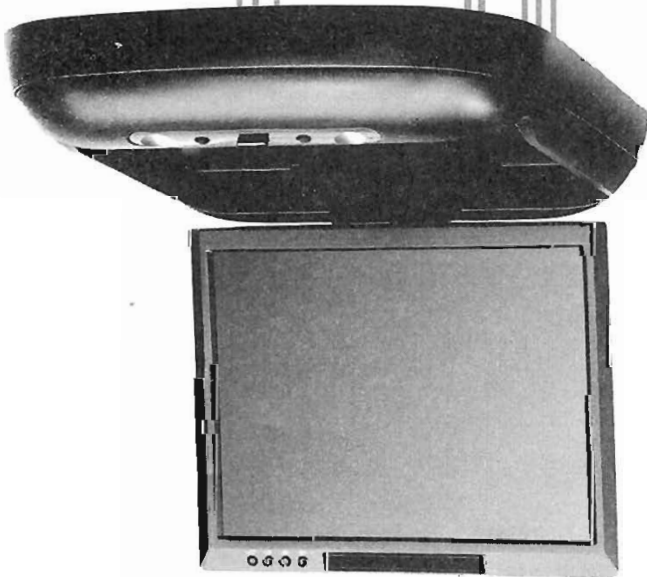

# SPECIFICATIONS

Power	DC 12V
Screen Format	4 : 3
Resolution	2400 X 600 dots
Brightness	350 cd/m <sup>2</sup>
Color System	NTSC / PAL Auto Selection
A/V Input	1 EA
Screen Size	10.4 Inch
IR Transmitter	Yes
Remote Control	Yes
Dimension	13.18"(W) X 13.18"(D) X 2.16"(H)

Note : This equipment has been tested and found to comply with the limits for a Class A digital device, pursuant to part 15 of the FCC Rules. These limits are designed to provide reasonable protection against harmful interference when the equipment is operated in a commercial environment. This equipment generates, uses, and can radiate radio frequency energy and, if not installed and used in accordance with the instruction manual, may cause harmful interference to radio communications. Operation of this equipment in a residential area is likely to cause harmful interference in which case the user will be required to correct the interference at his own expense.