

# OWNER'S MANUAL

## TFT 10" WIDE SCREEN CEILING MOUNT MONITOR



### CAUTION

Changes or modifications not expressly approved by the party responsible for compliance could void the user's authority to operate the equipment.

# Contents

We very thank for your purchase.

Please read this user's Manual in detail and use the set properly.

Caution .....	4~5
Name and function of each part .....	6
For Operating Monitor .....	7
Picture control .....	8~9
Auto picture control	
Manual picture control	
Screen mode control	
FM TX control function .....	10
SYSTEM choose function .....	11
RESET control .....	11
External Devices Connection .....	12
Connection Diagram .....	13
Specifications .....	14

## Caution

Please read and observe all warnings and instructions in this owner's manual and those marked on the unit. Retain this booklet for future reference. These are two kinds of alarm signs as follows.



The lightning flash with arrowhead symbol within an equilateral triangle is intended to alert the user to the presence of insulated "dangerous voltage" within the product's enclosure that may be of sufficient magnitude to constitute a risk of electric shock to person.



The Exclamation point within an equilateral triangle is intended to alert the user to the presence of important operating and maintenance (servicing) instructions in the literature accompanying the product.



**WARNING**



Driver never operates while driving.  
It may cause car accident by watching TV or Video While driving.



Do not disassemble or remodel the device without a qualified engineer.



Do not drop or give strong impact to the LCD panel.



Do not install the unit where it will interfere with airbag inflation or vehicle control, or where injury may occur should the vehicle come to a sudden stop.



Take care not to overload the cigarette lighter circuit, if used, by connecting too many components.



Always take care to keep liquids away from the product.



Wipe softly with a dry cloth, when you clean the product.  
(Do not use any type of solvent such as thinner, benzene, commercially available cleaners or antistatic spray)



Do not install the product near the heater vents or where it will be exposed to direct sunlight.

## Caution

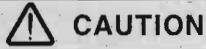

Quality installations are best performed by qualified and certified installers.



Watching monitor for an extended period of time without the engine running may deplete the vehicle's battery charge.



This product is designed for operation with a 12 Volt DC, negative ground vehicle. It is not suitable for operation under the other conditions or voltage.

### Check Point

1. The range of preservation temperature for the device is from  $-20^{\circ}\text{C}$  to  $80^{\circ}\text{C}$ . Be cautious that the inside temperature of car may arise up to  $100^{\circ}\text{C}$  in summer time.
2. The TV picture may not be displayed normally when it is higher or lower than the using temperature. In this case, the screen will be back normal condition in minutes. The range of using temperature for the device is from  $0^{\circ}\text{C}$  to  $40^{\circ}\text{C}$ .
3. You can watch the best picture condition when you are in the front side.



## Name and function of each part

### UNIT

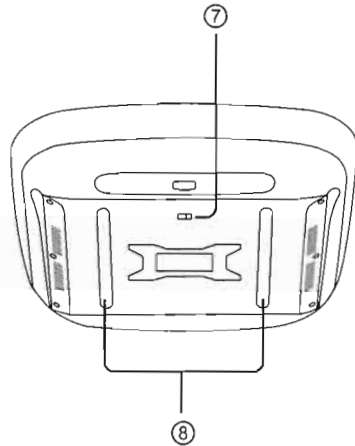
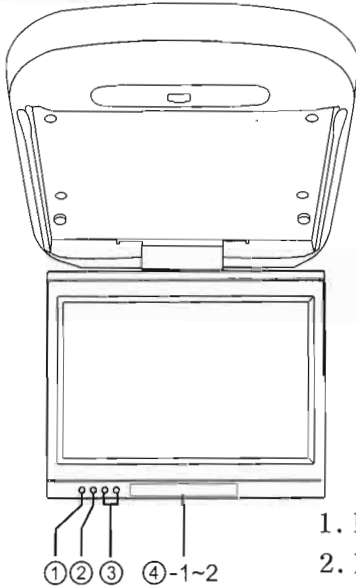

1. Power button.
2. Picture control.
3. Adjustment in each mode.
- 4-1. IR Wireless headphone transmitter.

As an installed audio signal into the device. The IR transmitter radiates infra-red ray which was transformed from the audio signal on the wireless headphone. The user is possible to listen by the wireless headphone.

- 4-2. Remote control sensor.
- sensor the IR of remote controller.

5. Auto picture control.
6. Selection in each mode.
7. Lamp button.
8. Lamp.

### Remote Control

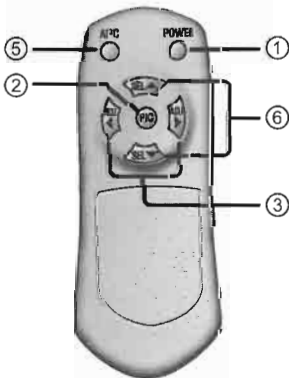

## For Operating Monitor

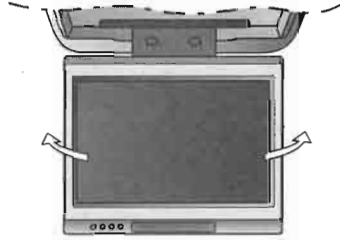
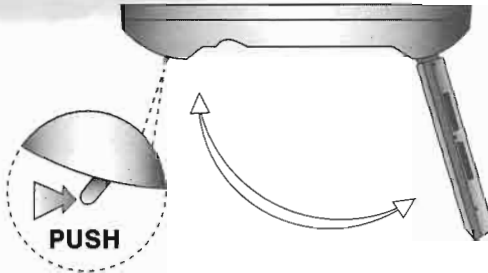

Eject monitor set by pressing **PUSH** button and then, adjust monitor set for your comfortable watching.

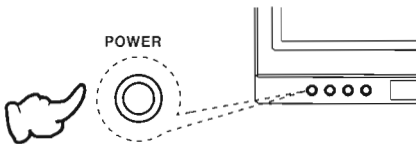

Press **POWER** button.  
Press the **POWER** button  
one more time to off the power.

※When closing the displayed monitor on the ceiling mount, it will automatically be turned off. When opening the monitor again, it will automatically be turned on.

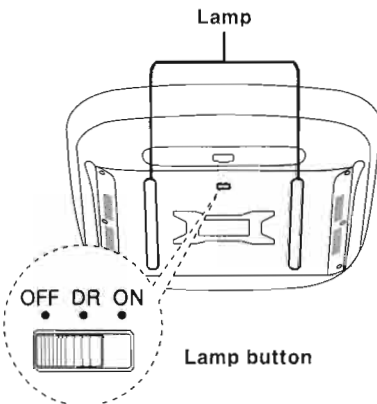

**Lamp button.**

**OFF** -When door is open or close, it is always off the light.

**DR** -When door is open, it will be turned on.  
When all door is close, it will be turned off.

**ON** -When door is open or close, it is always on the light.

# Picture control

## Auto picture control.



1. Press the "APC" button of the remote controller.
2. Whenever you press "APC" Button, picture condition is to be changed as follows.

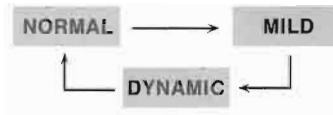

## Manual picture control.

### CONTRAST / BRIGHT / COLOR / TINT / SCREEN Selection.



1. Make Picture displayed by pressing "PIC" button.



2. Make the menu you want to adjust cyan-colored by pressing "SEL▲/▼" button on the remote controller or the "PIC" button on the unit.

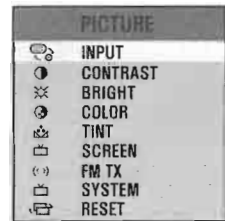

3. Adjust the picture condition you want by pressing "ADJ◀/▶" button.

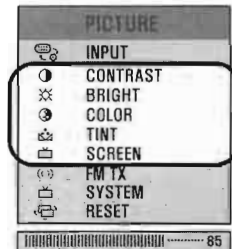

# Picture control

**Screen mode control.** (Adjust screen mode as your taste.)



1. Make Picture displayed by pressing "PIC" button.



2. Make the SCREEN item in cyan-colored on the menu by pressing "SEL▲/▼" button on the remote controller or the "PIC" button on the unit.

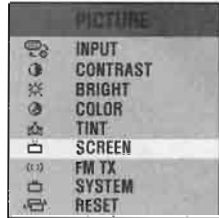

3. Adjust the picture condition you want by pressing "ADJ◀/▶" button.

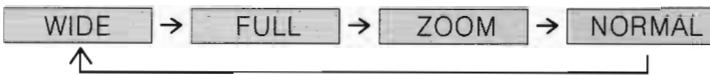

WIDE

The screen will be magnified to the ratio of 4x3 on the left and right sides.



FULL

Magnifies the picture in full screen.



ZOOM

The screen will be magnified on the left and right side of the picture to the ratio of 4x3 and will make the left and right sides of the picture displayed as well.



NORMAL

The screen will be the standard 4x3 ratio.



## FM TX control function

### Listening to Monitor sound through FM Radio.

(Unfold FM Radio antenna.)

1. Select Radio frequency to FM 88.3MHz ~ 90.1MHz.

**TUNE**



The diagram shows a hand pointing to a button labeled "TUNE" with up and down arrows. Below it are two buttons labeled "FM 88.3" and "FM 90.1" with a tilde symbol between them.

2. Make Picture displayed by pressing "PIC" button.

3. Make the FM TX item in cyan-colored on the menu by pressing "SEL▲/▼" button on the remote controller or the "PIC" button on the unit.

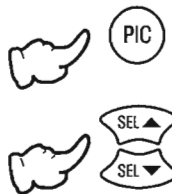

The diagram shows a hand pointing to a circular button labeled "PIC". Below it are two buttons labeled "SEL▲" and "SEL▼".

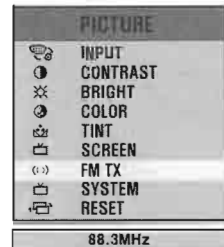

4. Select to frequency shown in number 1 by pressing "ADJ◀/▶" button.



The diagram shows a hand pointing to two buttons labeled "ADJ◀" and "ADJ▶".

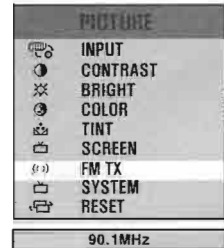

## SYSTEM choose function



1. Make Picture displayed by pressing "PIC" button.
2. Make the SYSTEM item in cyan-colored on the menu by pressing "SEL▲/▼" button on the remote controller or the "PIC" button on the unit.

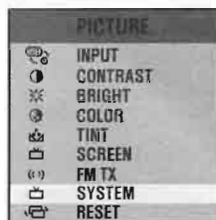

3. Press "ADJ◀/▶" and then choose NTSC or PAL mode.

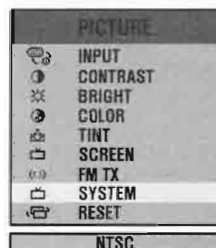

## RESET control

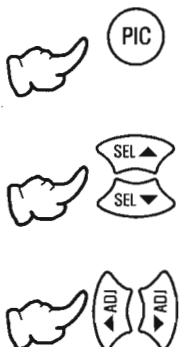

1. Make Picture displayed by pressing "PIC" button.
2. Make the RESET item in cyan-colored on the menu by pressing "SEL▲/▼" button on the remote controller or the "PIC" button on the unit.
3. Press "ADJ◀/▶" and then replace with the factory default values.

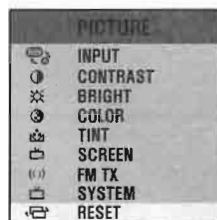

## External Devices Connection.

Connect with various external devices as following pictures.

### AV PACK

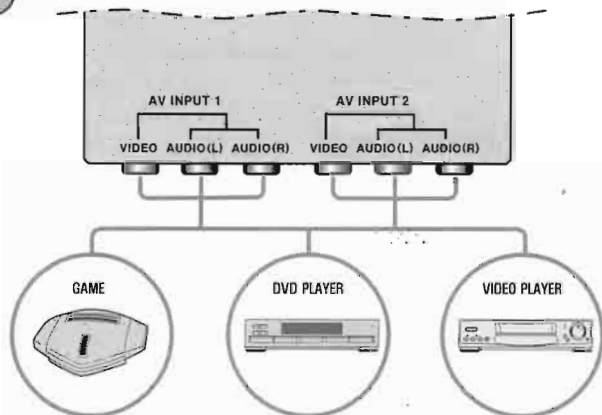

1. Make Picture displayed by pressing "PIC" button.



2. Make the INPUT item in cyan-colored on the menu by pressing "SEL▲/▼" button on the remote controller or the "PIC" button on the unit.

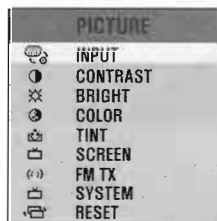

3. Adjust the picture condition you want by pressing "ADJ◀/▶" button.

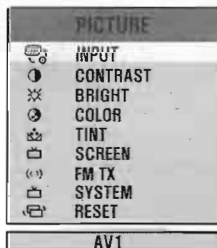

## Connection Diagram

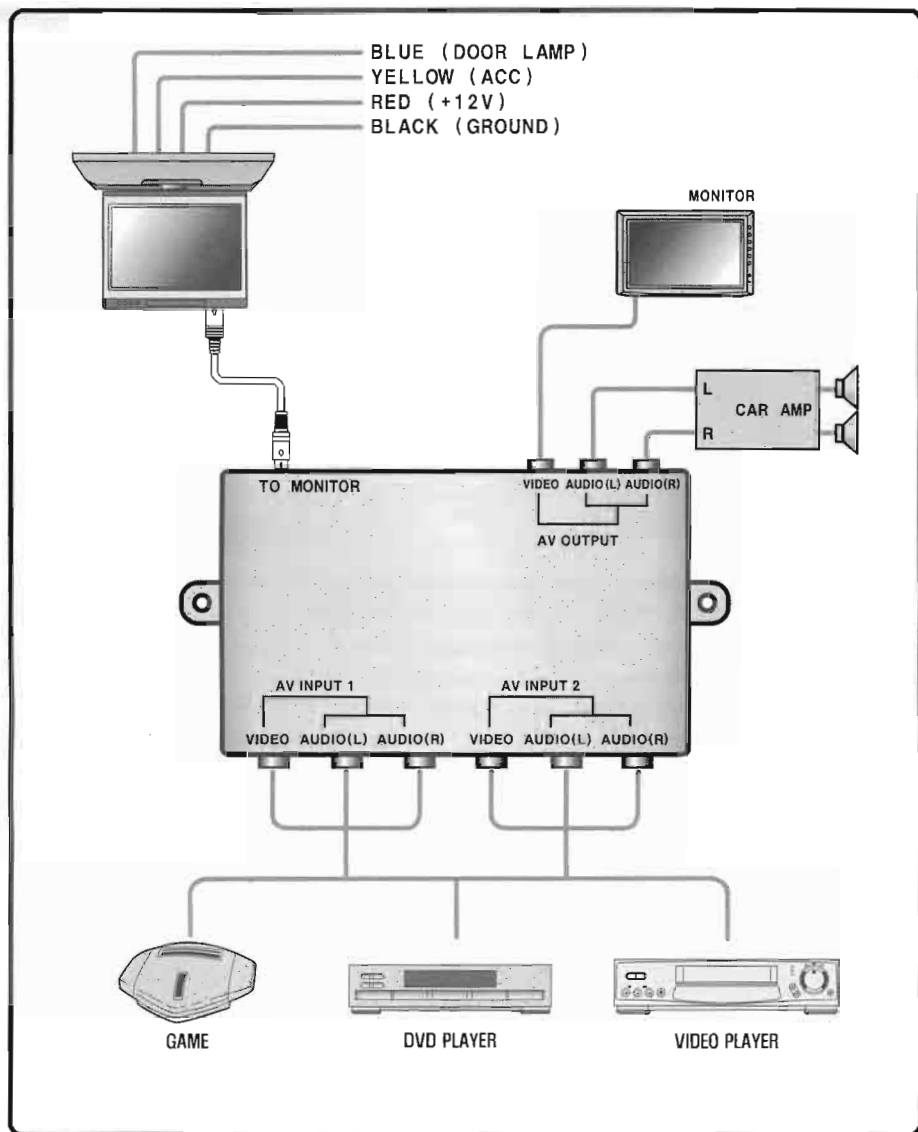

## Specifications

Power Requirements	DC 12V
Power Consumption	12W MAX
Screen Format	16:9
Resolution Pixel	1600 X 320 Pixel
Brightness Factor	220 cd/m <sup>2</sup>
Broadcast Mode	NTSC / PAL
AV Input	2 EA
AV Output	1 EA
Screen Size	10" WIDE SCREEN TFT LCD
IR Transmitter	Yes
Dome Lights	CCFL type
Remote Control	Yes
Dimensions	(W) 295 X (H) 317 X (D) 54mm

**Note** : This equipment has been tested and found to comply with the limits for a Class A digital device, pursuant to part 15 of the FCC Rules. These limits are designed to provide reasonable protection against harmful interference when the equipment is operated in a commercial environment. This equipment generates, uses, and can radiate radio frequency energy and, if not installed and used in accordance with the instruction manual, may cause harmful interference to radio communications. Operation of this equipment in a residential area is likely to cause harmful interference in which case the user will be required to correct the interference at his own expense.